

Neutrino Physics



Caren Hagner, Universität Hamburg

Part 1:

- What are neutrinos?
- Neutrino interactions, sources and detectors
- Majorana neutrinos
- Neutrino mass and mixing
- Neutrino oscillations
- Oscillations of atmospheric neutrinos (SuperK)

Part 2:

- Neutrino beams:
Oscillation of accelerator neutrinos (OPERA)
- Solar neutrinos:
Oscillation of solar neutrinos
(Homestake, SNO)
- KamLAND reactor neutrino experiment

Why are we doing Neutrino Physics?

Elementary Particle Physics:

- Mass?
- Matter - antimatter symmetry
- Physics beyond the Standard Model

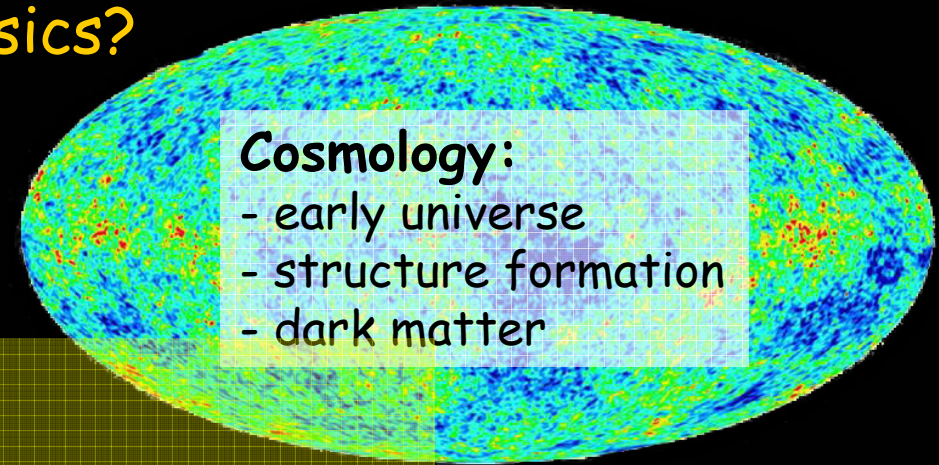

Cosmology:

- early universe
- structure formation
- dark matter

Neutrino Physics

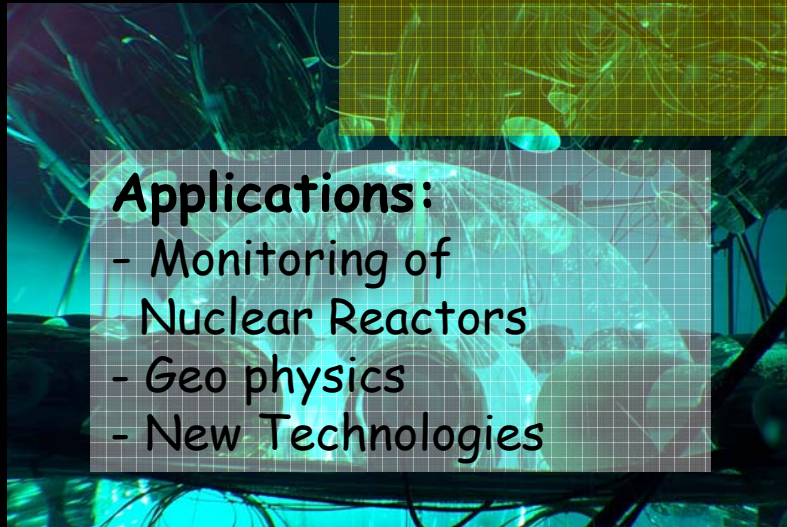

Applications:

- Monitoring of Nuclear Reactors
- Geo physics
- New Technologies

Astroparticle Physics:

- Solar Neutrinos
- Cosmic Radiation
- Supernovae
- Neutrino Telescopes

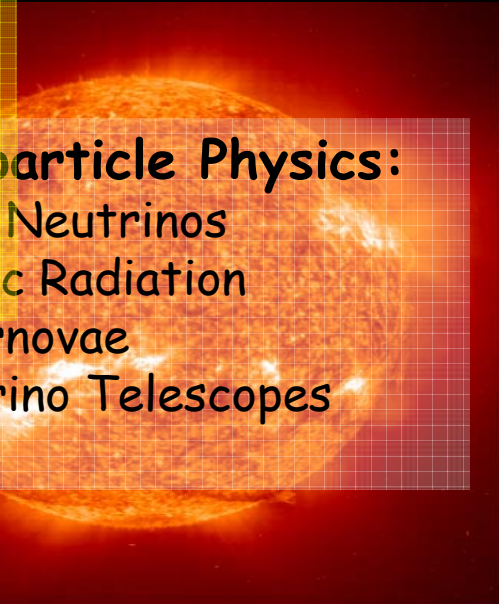

Wolfgang Pauli postulates the Neutrino (1930)

Energy spectrum of electrons from β -decay

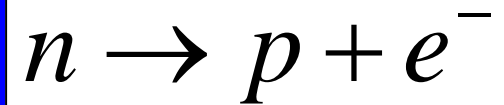

$$E_{electron} = m_n c^2 - m_p c^2$$

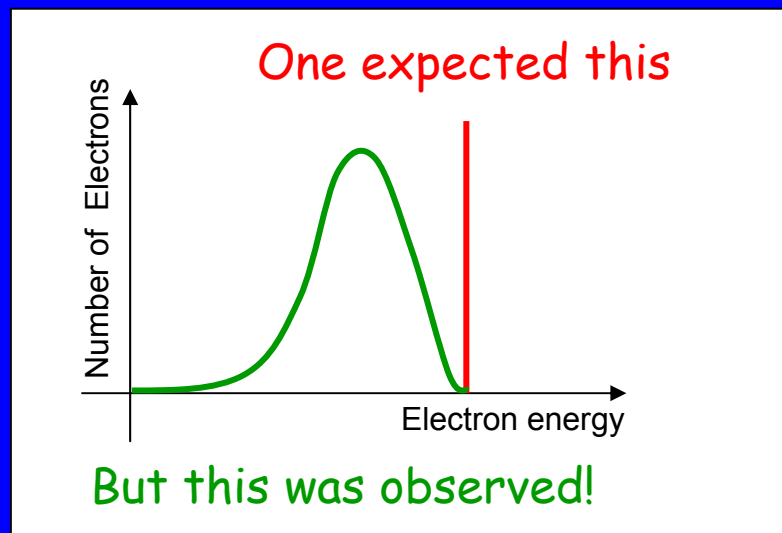

Solution:
The Neutrino

Wolfgang Pauli in Hamburg (1955)

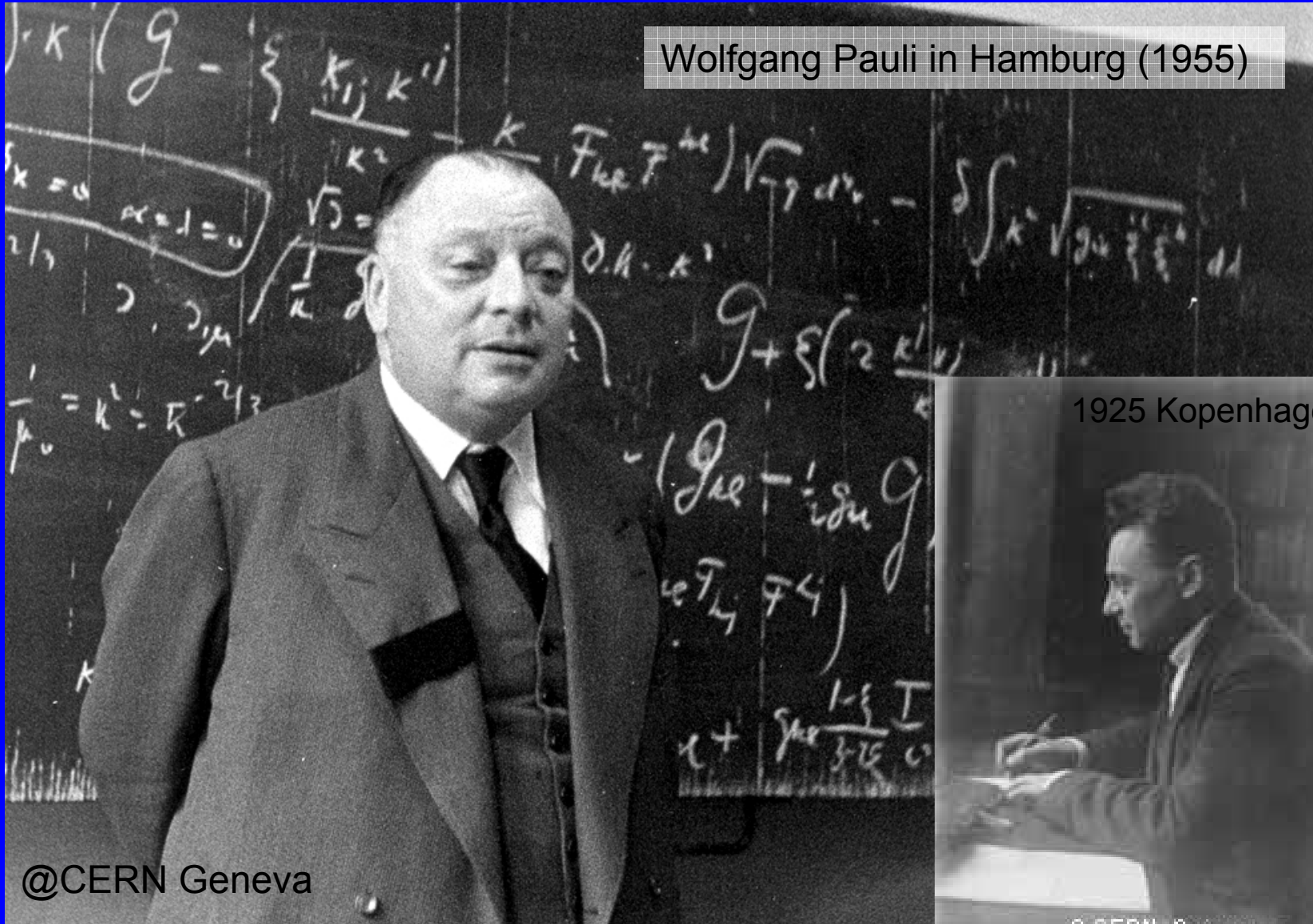

1922 Assistant at Universität Hamburg

1924 Habilitation in Hamburg (Discovery of the Exclusion Principle)

Decay of the Neutron - Birth of a Neutrino

Proton

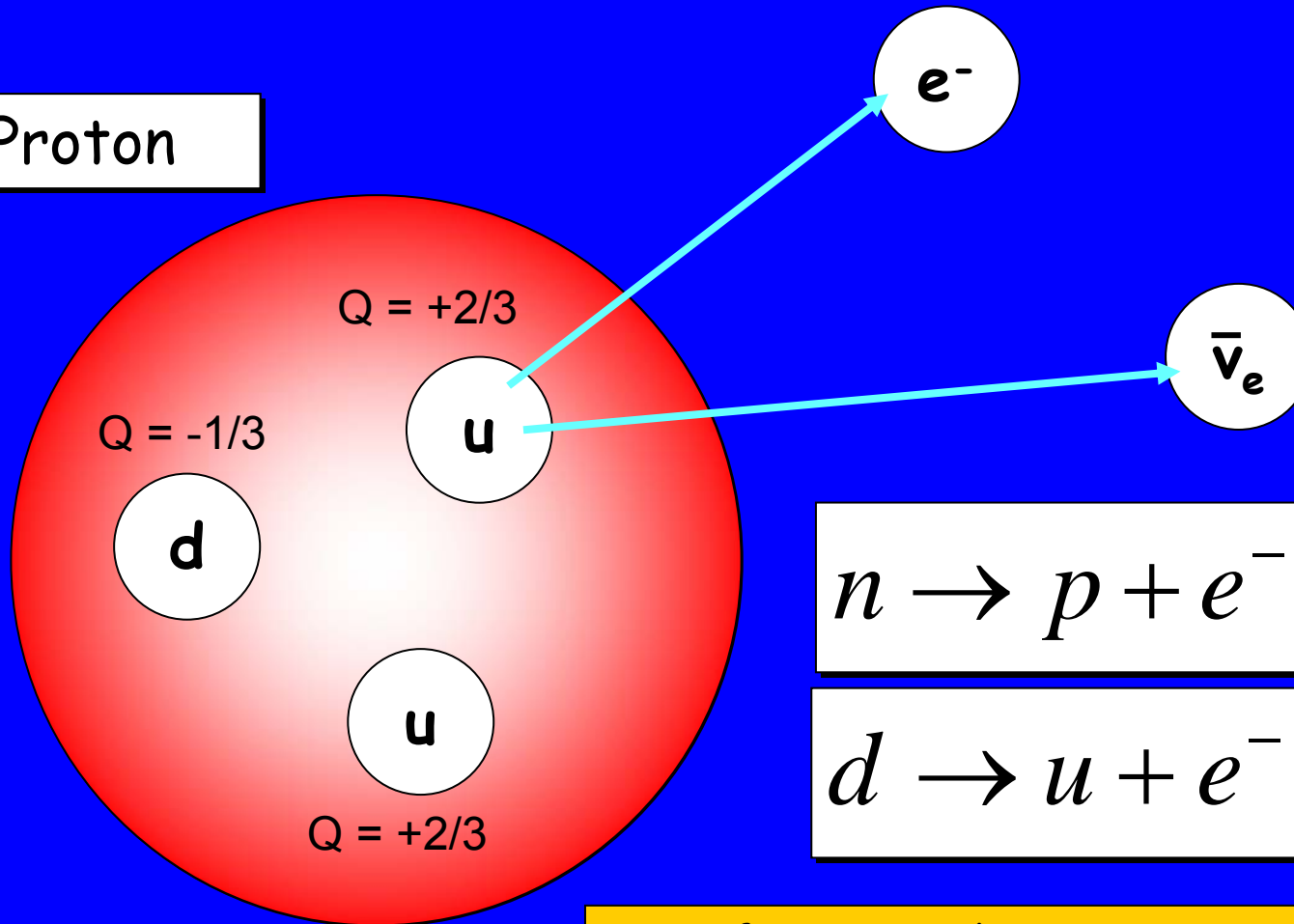

Transformation d-Quark \rightarrow u-Quark:
Electroweak Interaction!

First Detection of a Neutrino: 1956

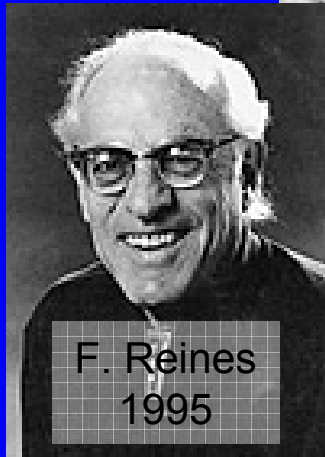
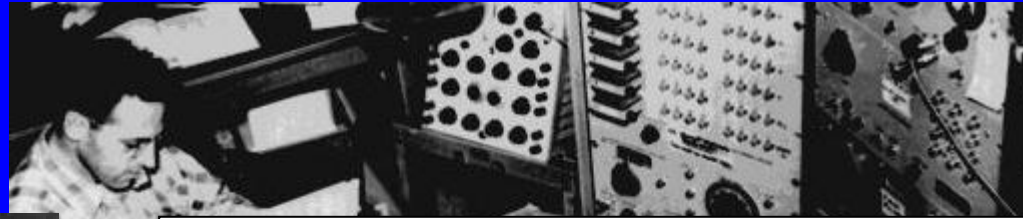

F. Reines
1995

Frederick REINES and Clyde COWAN
Box 1663, LOS ALAMOS, New Mexico
Thanks for message. Everything comes to
him who knows how to wait.

Pauli

Cowan und Reines

- Neutrino source: Nuclear reactor
- Detection Method: $\bar{\nu}_e + p \rightarrow e^+ + n$
- Detector: Scintillator, PMT's

Neutrino History

- 1930: neutrino postulated by Pauli (massless, neutral)
- 1956: neutrino ν_e detected by Reines and Cowan (Nobel prize 1995)
- 1962: Discovery of ν_μ at AGS in Brookhaven by Ledermann, Schwartz and Steinberger (Nobel prize 1988)
- 1975: neutrino ν_τ postulated after τ lepton was discovered by M. Perl et al.
- 2000: First direct detection of ν_τ by the DONUT experiment (Fermilab)

- ~ 1995: LEP measurement of Z^0 decay width:
→ 3 active neutrino flavors ($m_\nu < 80 \text{ GeV}$):
$$N_\nu = 3.00 \pm 0.06$$
$$\nu_e, \nu_\mu, \nu_\tau$$

Fundamental Particles

Quarks:

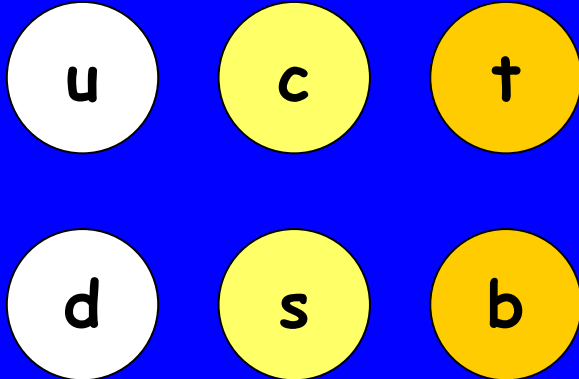

Leptons:

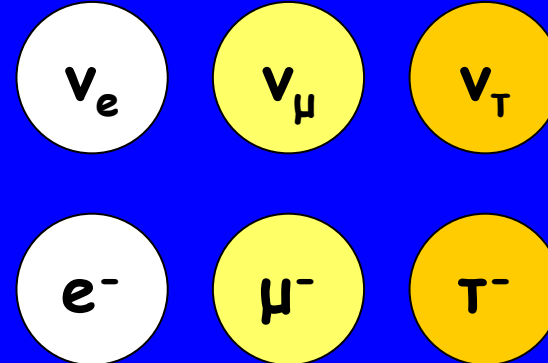

Interactions by exchange of bosons:

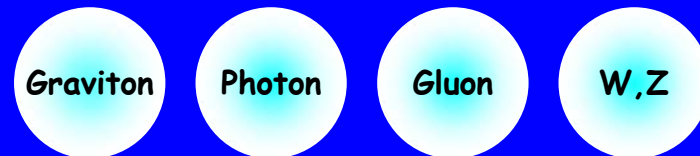

Neutrino Properties

- Neutral
- Fermions with Spin $\frac{1}{2}$
- In the Standard Model:
massless, stable, always left handed!

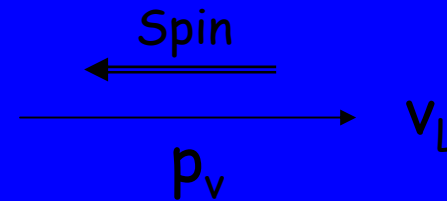

- **BUT:** Today we know that neutrinos have mass
 $0.05 \text{ meV} < m_\nu < 2 \text{ eV}$
Standard Model must be extended!
- Are Neutrinos and Anti-Neutrinos identical?
- many other properties are still unknown:
sterile neutrinos?, CP-violation?, neutrino decay?,
magnetic moment?...

How Neutrinos interact

- The weak interaction

$$\begin{pmatrix} u \\ d \end{pmatrix}_L \quad \begin{pmatrix} c \\ s \end{pmatrix}_L \quad \begin{pmatrix} t \\ b \end{pmatrix}_L$$

$$\begin{pmatrix} \nu_e \\ e^- \end{pmatrix}_L \quad \begin{pmatrix} \nu_\mu \\ \mu^- \end{pmatrix}_L \quad \begin{pmatrix} \nu_\tau \\ \tau^- \end{pmatrix}_L$$

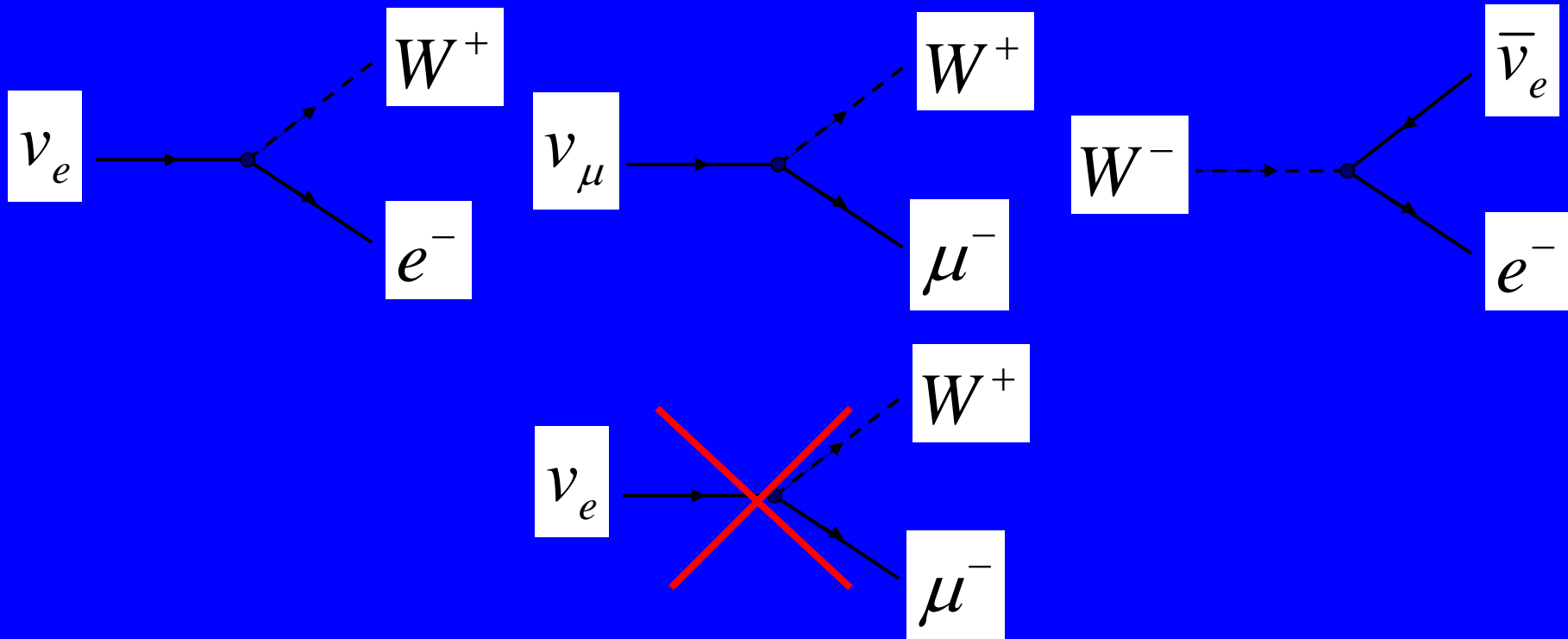

Charged Current

- Exchange of a W Boson:

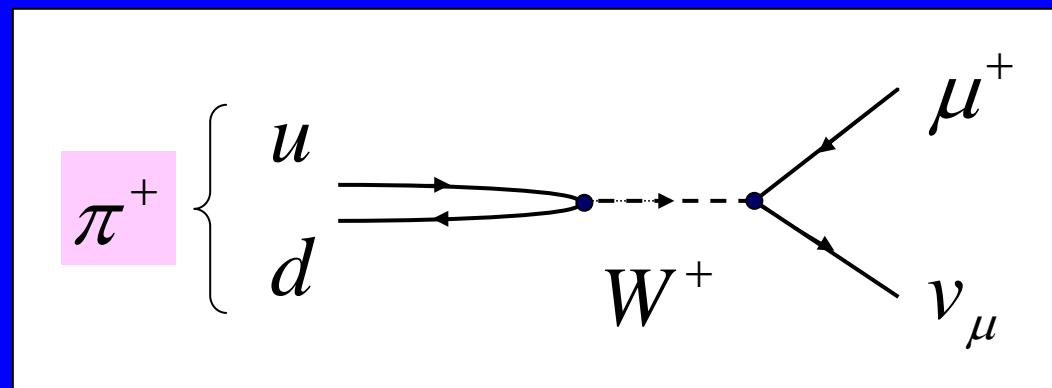
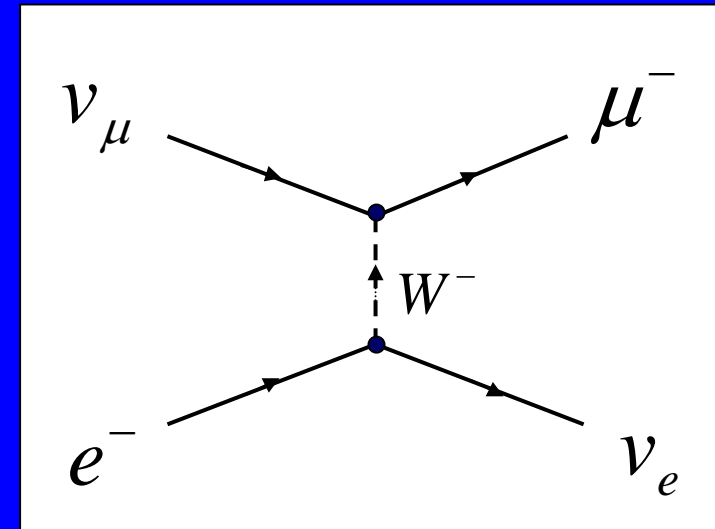
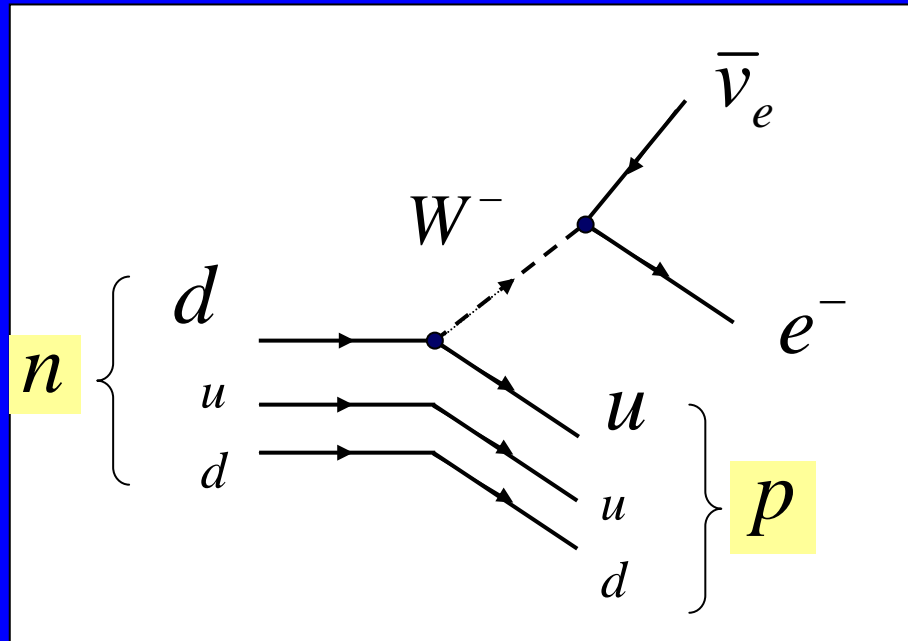

Neutral Current

- Exchange of a Z^0 Boson:

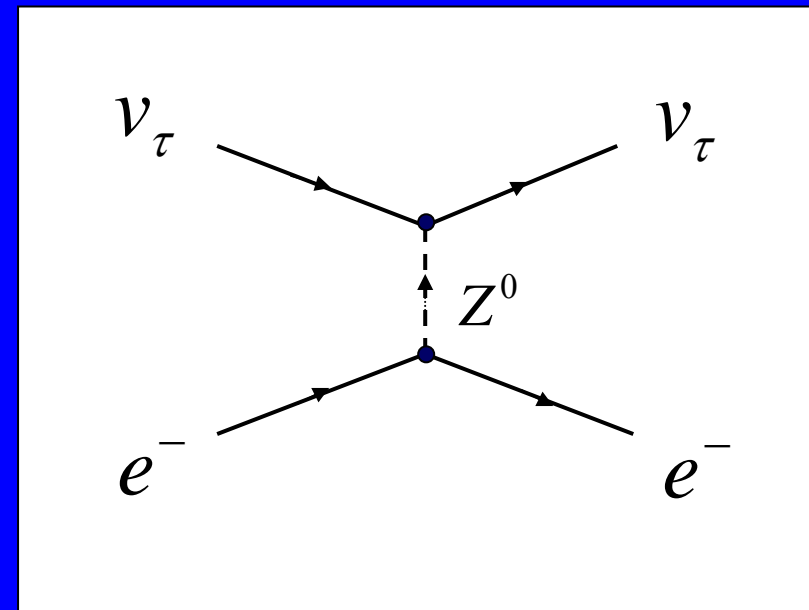
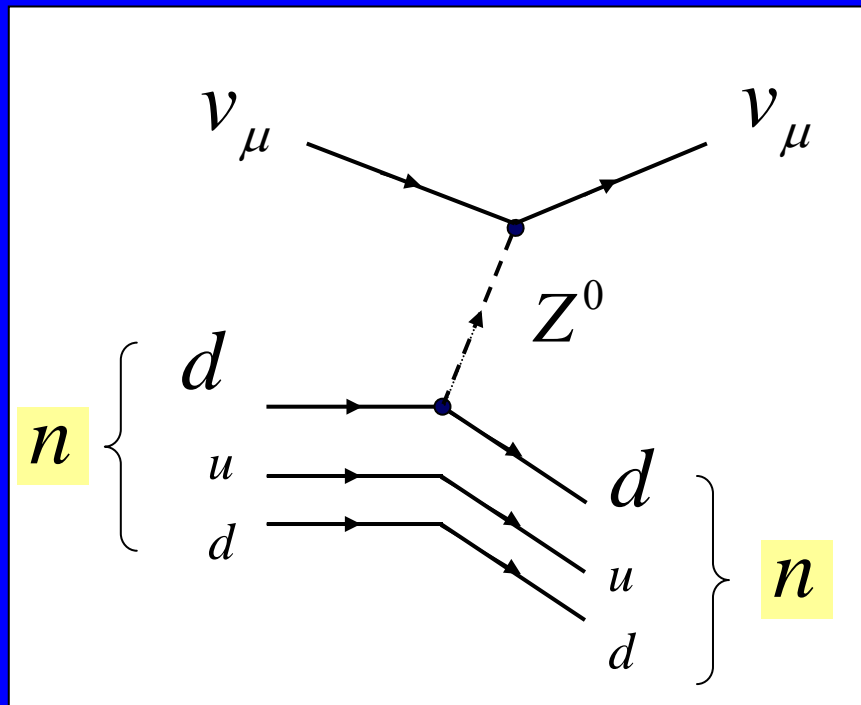

What do we know about neutrino masses?

- ν_e
- ν_μ
- ν_τ

$$\Delta m^2_{\text{solar}} \approx 8 \cdot 10^{-5} \text{eV}^2, \quad \Delta m^2_{\text{atm}} \approx 2 \cdot 10^{-3} \text{eV}^2$$

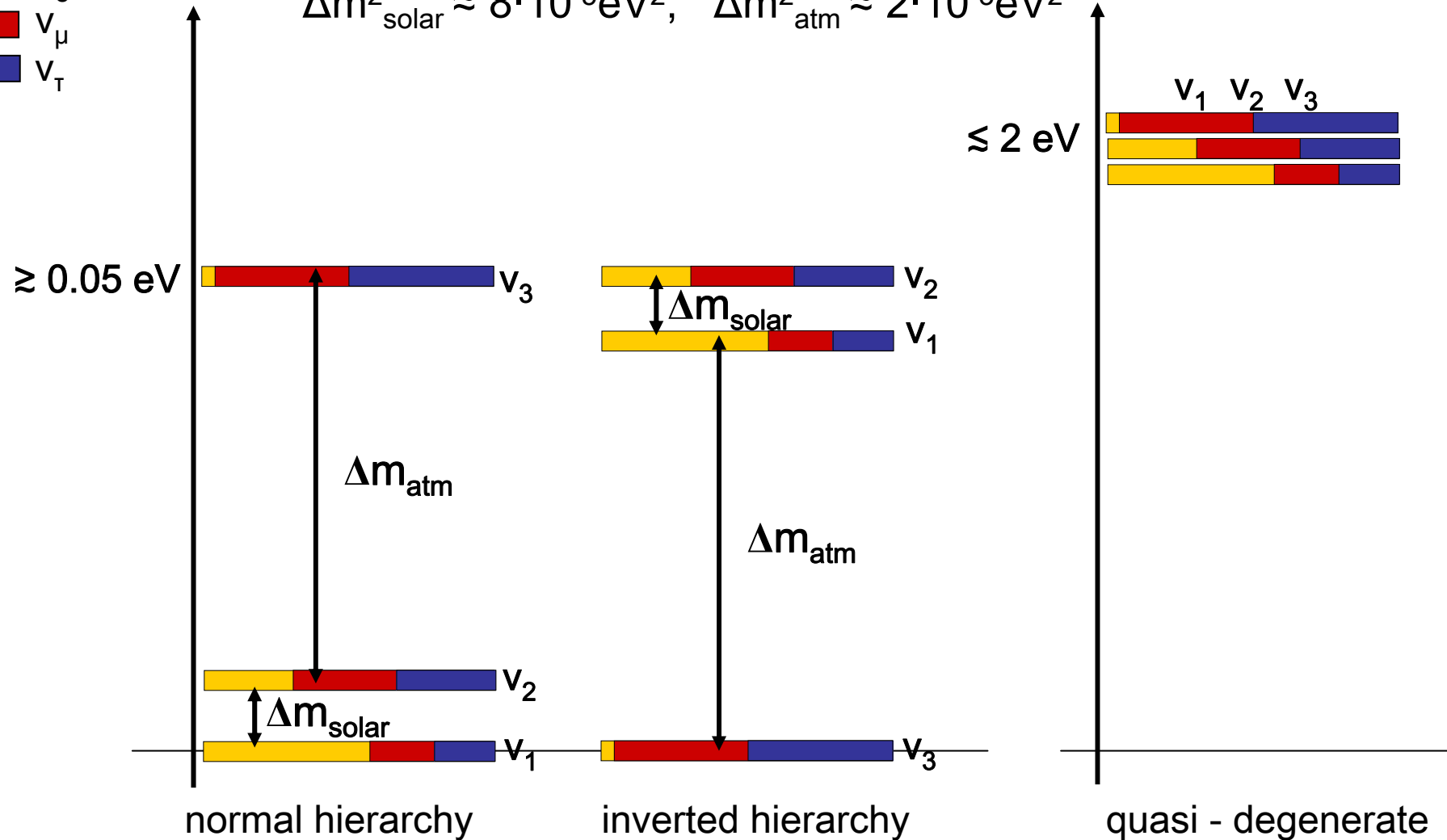

Tritium β -Decay: Mainz/Troitsk

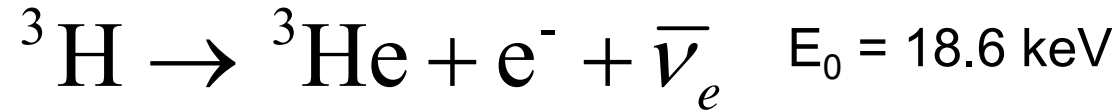

$$dN/dE = K \times F(E,Z) \times p \times E_{\text{tot}} \times (E_0 - E_e) \times [(E_0 - E_e)^2 - m_\nu^2]^{1/2}$$

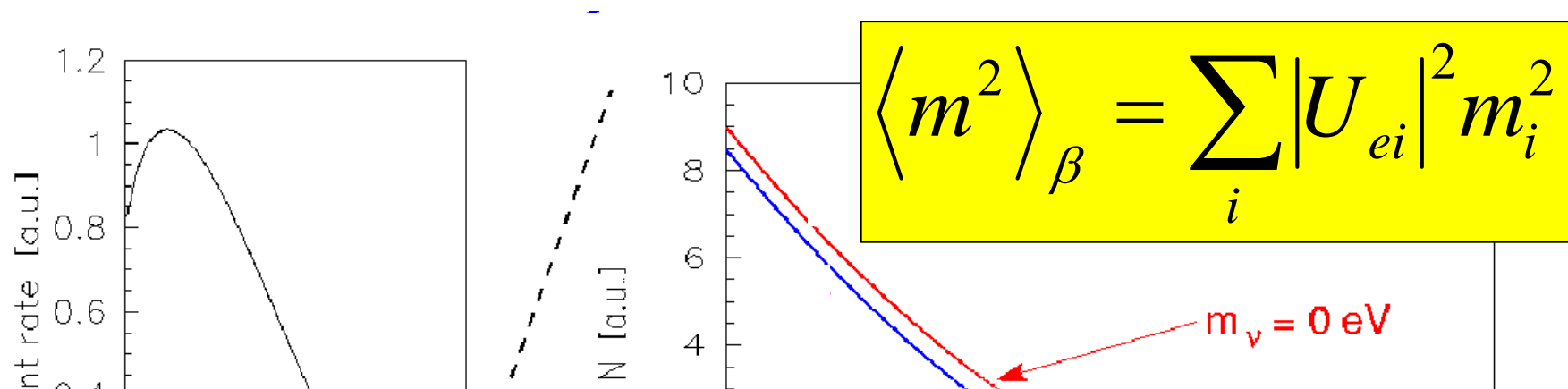

Mainz Data (1998,1999,2001)

$$\langle m^2 \rangle_\beta = -1.2 \pm 2.2 \pm 2.1 \text{ eV}^2 \quad \Rightarrow \quad \langle m \rangle_\beta < 2.2 \text{ eV} \quad (95\% \text{CL})$$

KATRIN: delivery of vacuum vessel (2008)



Are Neutrinos Majorana Particles?



Because neutrinos carry no electric charge
(and no color charge), there is the possibility:

particle \equiv anti-particle

Majorana particle

particle ψ

anti-particle (charge conjugate field): $\psi^c = C \bar{\psi}^T$

for a Majorana particle: $\psi_M^c = \pm \psi_M$

But what about experiments?

Neutrinos (solar): $\nu_{eL} + {}^{37}\text{Cl} \rightarrow {}^{37}\text{Ar} + e^-$ **observed!**

Anti-neutrinos(reactor): $\bar{\nu}_{eR} + {}^{37}\text{Cl} \rightarrow {}^{37}\text{Ar} + e^-$ **not observed!**

There are two different states per flavor

but the difference could be due to left-handed and right-handed states!

2ν and 0ν double beta - decay

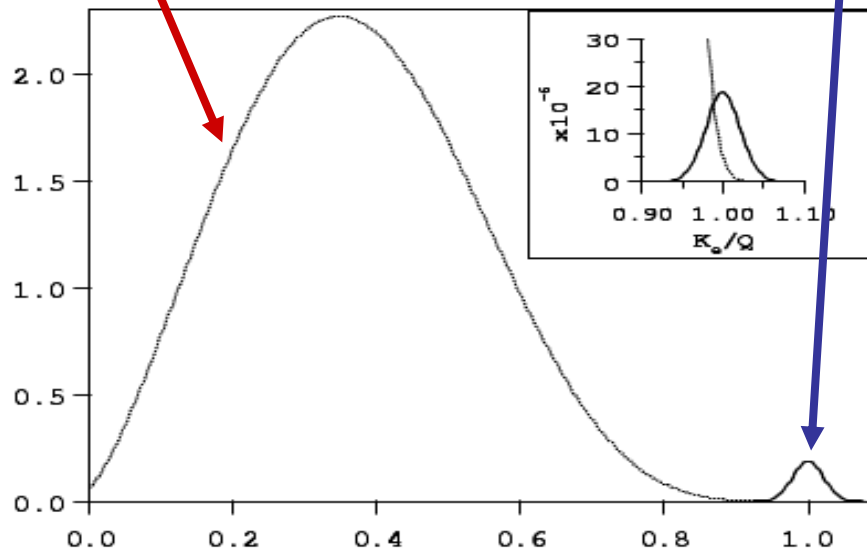
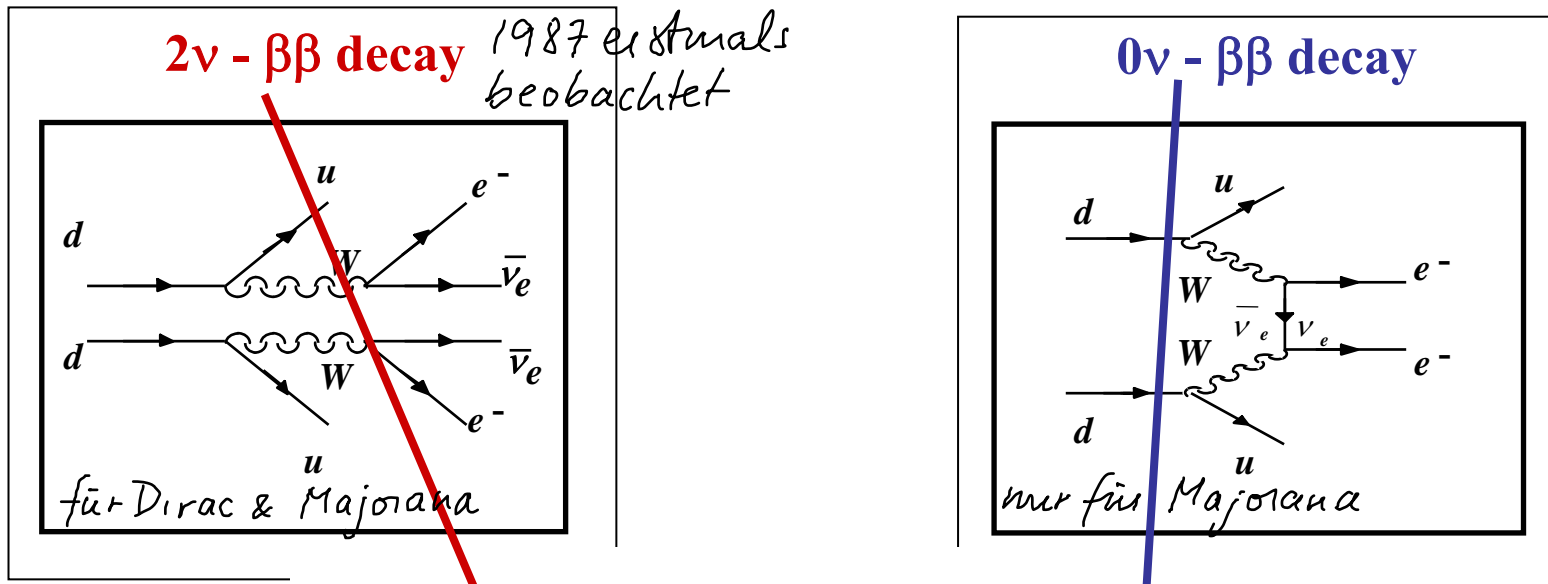

Sum energy of electrons (E/Q)

0ν Doppel-Beta experiments: results

$$\langle m \rangle_{\beta\beta} < 0.35 \text{ eV (90\% CL)}$$

Heidelberg-Moskau Collaboration, Eur.Phys.J. A12 (2001) 147

IGEX Collaboration, hep-ex/0202026, Phys. Rev. C59 (1999) 2108

Isotope	$T_{1/2}^{0\nu}$ (y)	$\langle m_\nu \rangle$ (eV)
^{48}Ca	$> 9.5 \times 10^{21}$ (76%)	< 8.3
^{76}Ge	$> 1.9 \times 10^{25}$ HM-K	< 0.35
	$> 1.6 \times 10^{25}$ IGEX	$< 0.33 - 1.35$
^{82}Se	$> 2.7 \times 10^{22}$ (68%)	< 5
^{100}Mo	$> 5.5 \times 10^{22}$	< 2.1
^{116}Cd	$> 7 \times 10^{22}$	< 2.6
^{128}Te	$> 7.7 \times 10^{24}$	$< 1.1 - 1.5$
^{130}Te	$> 2.1 \times 10^{23}$	$< 0.85 - 2.1$
^{136}Xe	$> 4.4 \times 10^{23}$	$< 1.8 - 5.2$
^{150}Nd	$> 1.2 \times 10^{21}$	< 3

all 90%CL

Heidelberg-Moskau Experiment (HDM)



5 Ge-Detektoren
(angereichert mit ^{76}Ge)
„Die Detektoren zerfallen!“



CUORICINO \rightarrow CUORE

2v double beta with ^{130}Te ($Q=2529$ keV)

18 crystals $3 \times 3 \times 6$ cm³ + 44 crystals $5 \times 5 \times 5$ cm³

40.7 kg of TeO_2 \rightarrow 750 kg TeO_2
 \rightarrow 203 kg ^{130}Te

from 2003-2008

search for 0v double beta:

$$T_{1/2}^{0\nu} (^{130}\text{Te}) > 7.5 \times 10^{23} \text{ y}$$

$$\langle m_\nu \rangle < 0.3 - 1.6 \text{ eV}$$

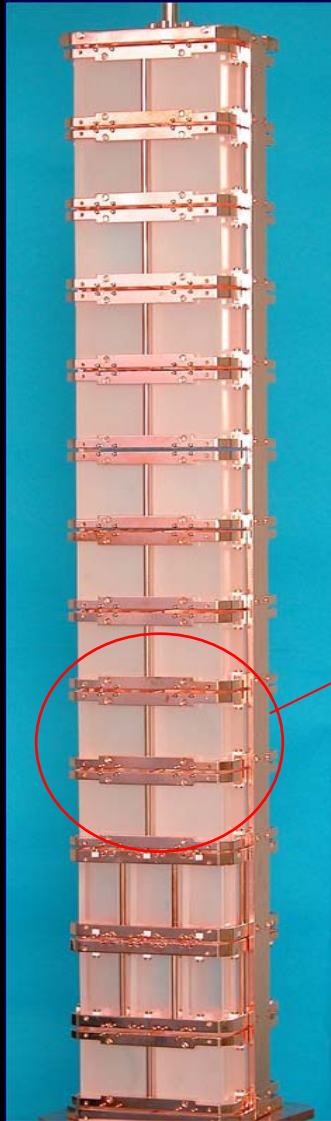

2 modules, 9 detector each,
crystal dimension $3 \times 3 \times 6$ cm³
crystal mass 330 g
 $9 \times 2 \times 0.33 = 5.94$ kg of TeO_2

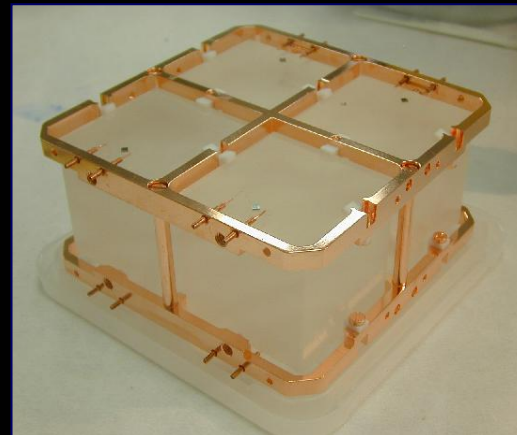

11 modules, 4 detector each,
crystal dimension $5 \times 5 \times 5$ cm³
crystal mass 790 g
 $4 \times 11 \times 0.79 = 34.76$ kg of TeO_2



Neutrino mass and mixing

3 massive neutrinos: ν_1, ν_2, ν_3 with masses: m_1, m_2, m_3

Flavor-Eigenstates $\nu_e, \nu_\mu, \nu_\tau \neq$ Mass-Eigenstates

Neutrino mixing!

$$\begin{pmatrix} \nu_e \\ \nu_\mu \\ \nu_\tau \end{pmatrix} = \begin{pmatrix} U_{e1} & U_{e2} & U_{e3} \\ U_{\mu1} & U_{\mu2} & U_{\mu3} \\ U_{\tau1} & U_{\tau2} & U_{\tau3} \end{pmatrix} \cdot \begin{pmatrix} \nu_1 \\ \nu_2 \\ \nu_3 \end{pmatrix}$$

Example: $|\nu_e\rangle = U_{e1}|\nu_1\rangle + U_{e2}|\nu_2\rangle + U_{e3}|\nu_3\rangle$

Neutrino Mixing for 2 Flavors

$$\begin{pmatrix} \nu_\mu \\ \nu_\tau \end{pmatrix} = \begin{pmatrix} \cos\theta_{23} & \sin\theta_{23} \\ -\sin\theta_{23} & \cos\theta_{23} \end{pmatrix} \begin{pmatrix} \nu_2 \\ \nu_3 \end{pmatrix}$$

$$|\nu_\mu\rangle = \cos\theta_{23}|\nu_2\rangle + \sin\theta_{23}|\nu_3\rangle$$

The probability that ν_μ has mass m_2 is $\cos^2\theta_{23}$
mixing angle \rightarrow probability to have a certain mass

Today we know that $\theta_{23} \approx 45^\circ$:

$$|\nu_\mu\rangle = \frac{1}{\sqrt{2}}(|\nu_2\rangle + |\nu_3\rangle) \quad |\nu_\tau\rangle = \frac{1}{\sqrt{2}}(-|\nu_2\rangle + |\nu_3\rangle)$$

e.g. probability that ν_μ has mass m_2 : 50%

Parametrisation of Neutrino Mixing

Pontecorvo-Maki-Nakagawa-Sakata (PMNS) Matrix:

- 3 mixing angles: θ_{12} , θ_{23} , θ_{13}
- 1 Dirac-phase (CP violating): δ

$$\begin{pmatrix} \nu_e \\ \nu_\mu \\ \nu_\tau \end{pmatrix} = \begin{pmatrix} 1 & 0 & 0 \\ 0 & c_{23} & s_{23} \\ 0 & -s_{23} & c_{23} \end{pmatrix} \begin{pmatrix} c_{13} & 0 & s_{13}e^{-i\delta} \\ 0 & \theta_{13}, \delta & 0 \\ -s_{13}e^{i\delta} & 0 & c_{13} \end{pmatrix} \begin{pmatrix} c_{12} & s_{12} & 0 \\ -s_{12} & c_{12} & 0 \\ 0 & 0 & 1 \end{pmatrix} \begin{pmatrix} \nu_1 \\ \nu_2 \\ \nu_3 \end{pmatrix}$$

$$\theta_{23}: 34^\circ - 58^\circ$$

$$\theta_{13} < 13^\circ, \delta ?$$

$$\theta_{12}: 29^\circ - 39^\circ$$

Leptons vs Quarks

$$\begin{array}{l} \text{Neutrinos} \\ U_{MNSP} \end{array} \sim \begin{pmatrix} 0.8 & 0.5 & ? \\ 0.4 & 0.6 & 0.7 \\ 0.4 & 0.6 & 0.7 \end{pmatrix}$$

$$\begin{array}{l} \text{Quarks} \\ V_{CKM} \end{array} \sim \begin{pmatrix} 1 & 0.2 & 0.005 \\ 0.2 & 1 & 0.04 \\ 0.005 & 0.04 & 1 \end{pmatrix}$$

Neutrino Oscillations

$$\begin{pmatrix} \nu_\mu \\ \nu_\tau \end{pmatrix} = \begin{pmatrix} \cos\theta_{23} & \sin\theta_{23} \\ -\sin\theta_{23} & \cos\theta_{23} \end{pmatrix} \begin{pmatrix} \nu_2 \\ \nu_3 \end{pmatrix}$$

Flavor eigenstates ν_μ, ν_τ

Mass eigenstates ν_2, ν_3
with m_2, m_3

source creates
flavor-eigenstates

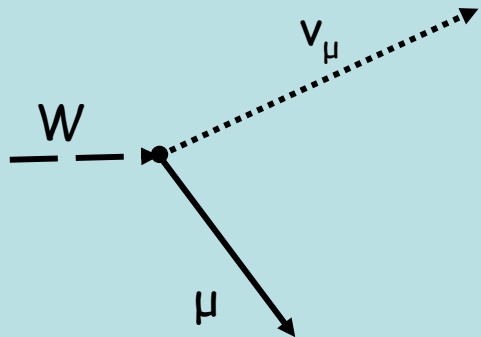

propagation determined by
mass-eigenstates

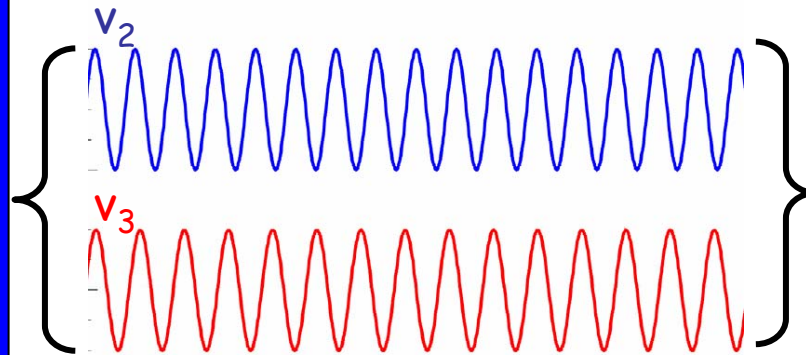

$$\omega_{2,3} = E_{2,3} = \sqrt{p^2 + m_{2,3}^2}$$

slightly different frequencies
→ phase difference changes

detector sees
flavor-eigenstates

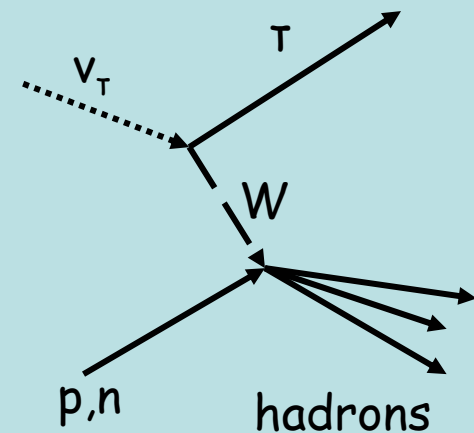

2 Flavor Neutrino Oscillations

Oscillation probability

$$P(\nu_\mu \rightarrow \nu_\tau) = \sin^2(2\theta_{23}) \cdot \sin^2\left(\pi \frac{x}{L_{osz}}\right)$$

$$L_{osz} \text{ (in km)} = \frac{2.48 \cdot E \text{ (in GeV)}}{\Delta m^2 \text{ (in eV}^2)}$$

$$\Delta m^2 = m_2^2 - m_3^2$$

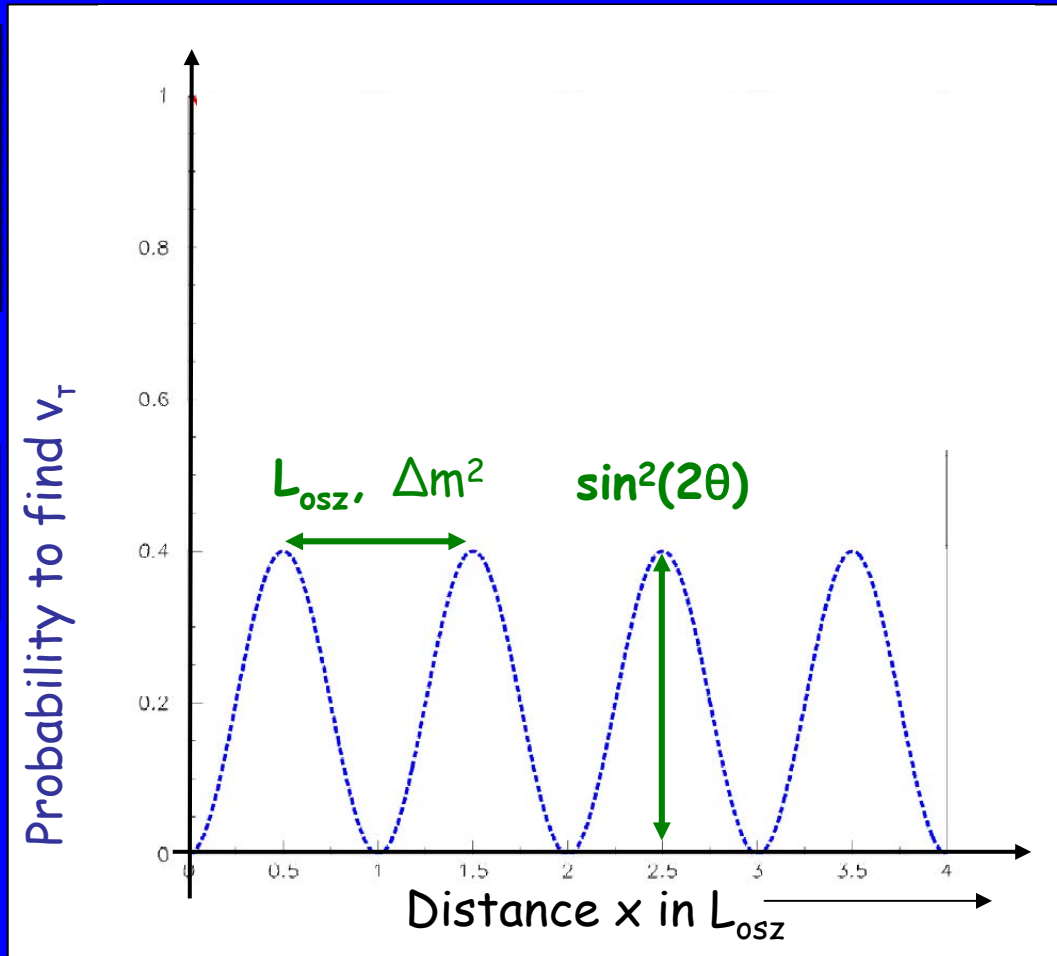

Neutrino Oscillations were observed → Neutrinos have mass!

JAPAN

Super-Kamiokande

$$\nu_{\mu} \rightarrow \nu_{\tau, (s)}$$

Oscillation

$$\Delta m^2 \approx 2 \cdot 10^{-3} \text{ eV}^2$$

+ MINOS (USA)

atmospheric neutrinos
accelerator neutrinos

CANADA

SNO

$$\nu_e \rightarrow \nu_{\mu, \tau}$$

Oscillation

$$\Delta m^2 \approx 8 \cdot 10^{-5} \text{ eV}^2$$

+ NEW:
BOREXINO @
LNGS (Italy)

solar neutrinos

JAPAN

KamLAND

reactor neutrinos

Let us first look how muon neutrinos oscillate

- Sources of muon neutrinos are:
The atmosphere (cosmic rays)
Neutrino beams at particle accelerators
- These neutrinos have energies of a few GeV
- Detection with methods of high energy particle physics
(Water Cherenkov)

Primary cosmic ray

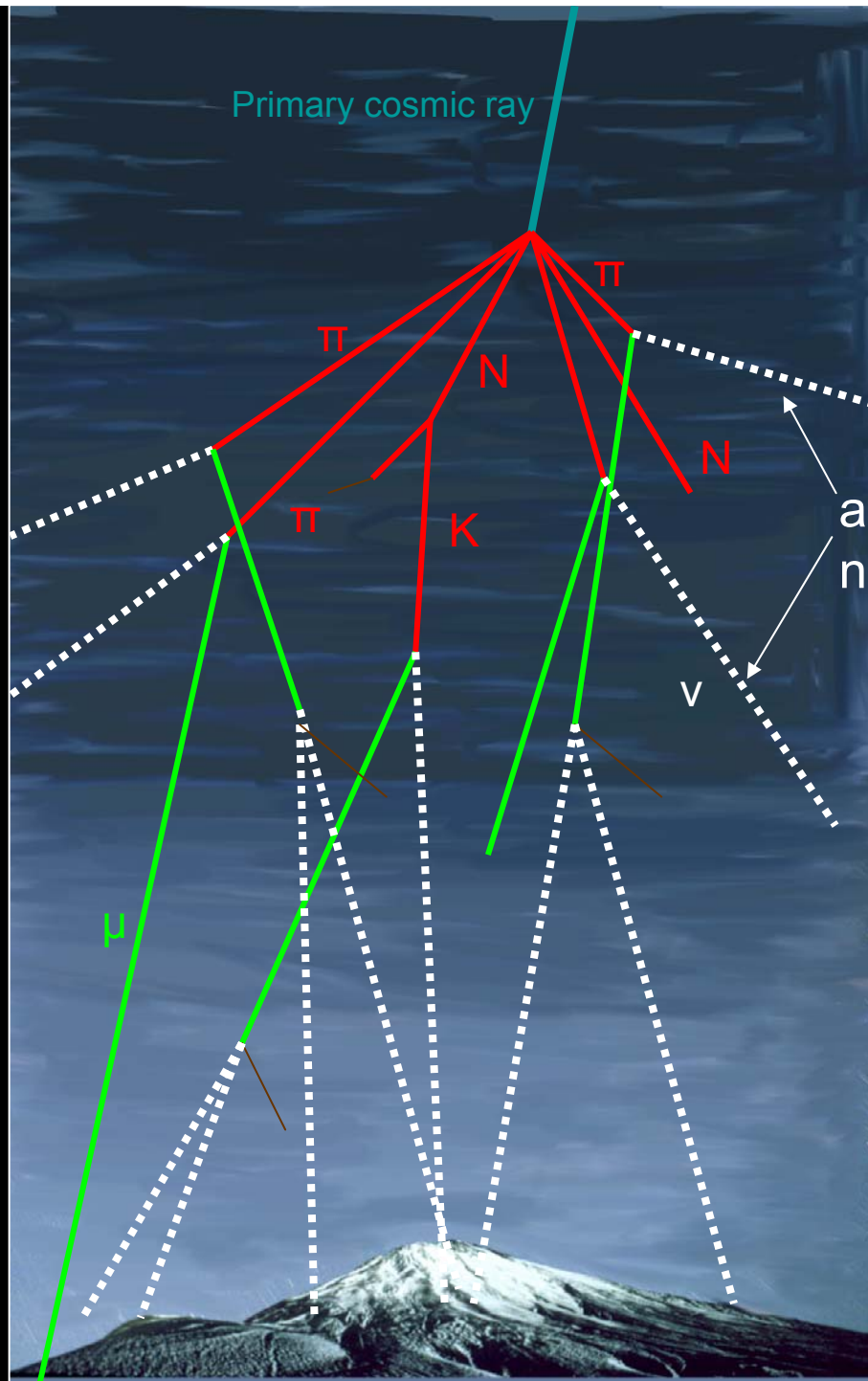

atmospheric neutrinos

Oscillation of atmospheric neutrinos (1998)

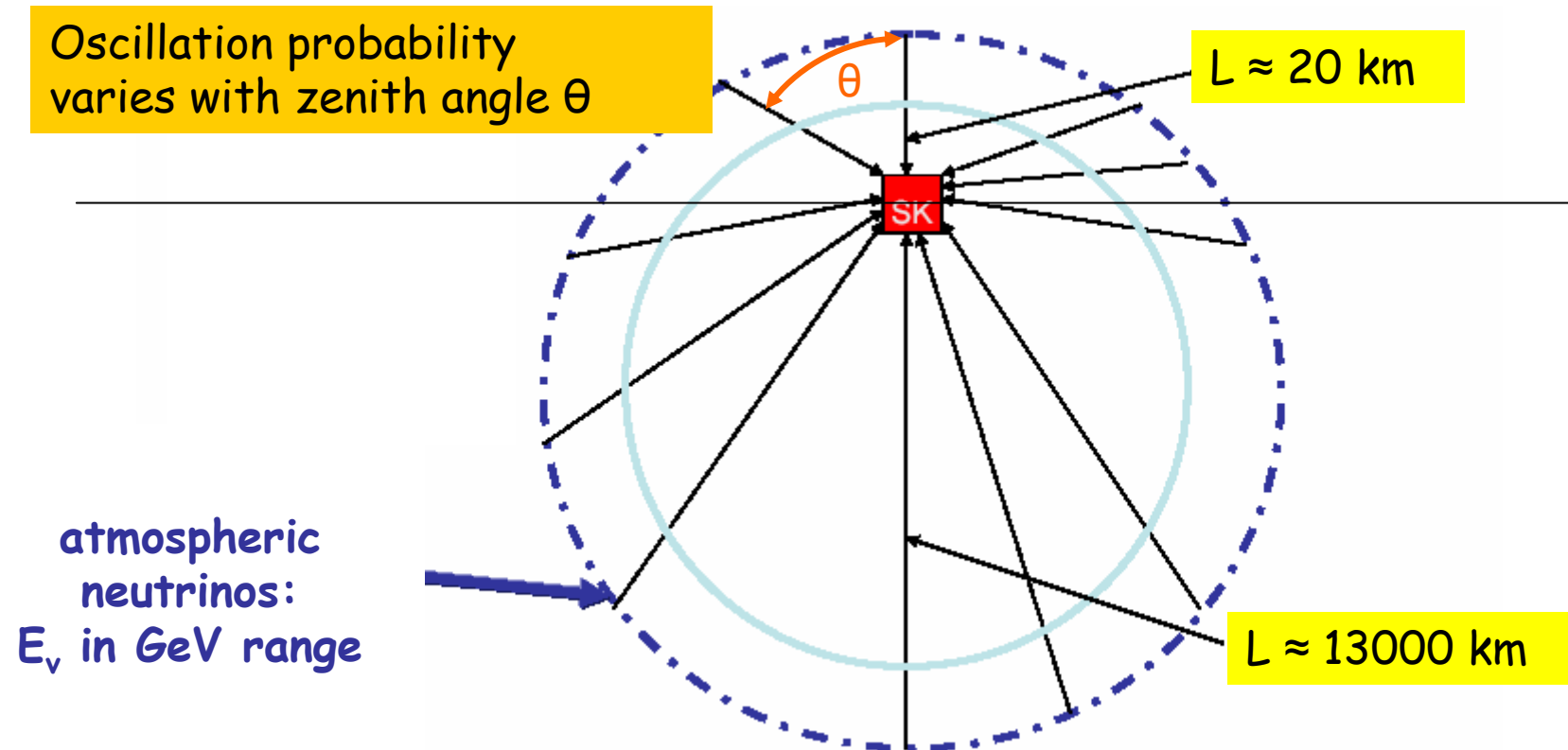

$$P(\nu_\mu \rightarrow \nu_x) = \sin^2 2\theta_{atm} \sin^2 \left(\frac{1.27 \Delta m_{atm}^2 [\text{eV}^2] L [\text{km}]}{E_\nu [\text{GeV}]} \right)$$

Super-Kamiokande

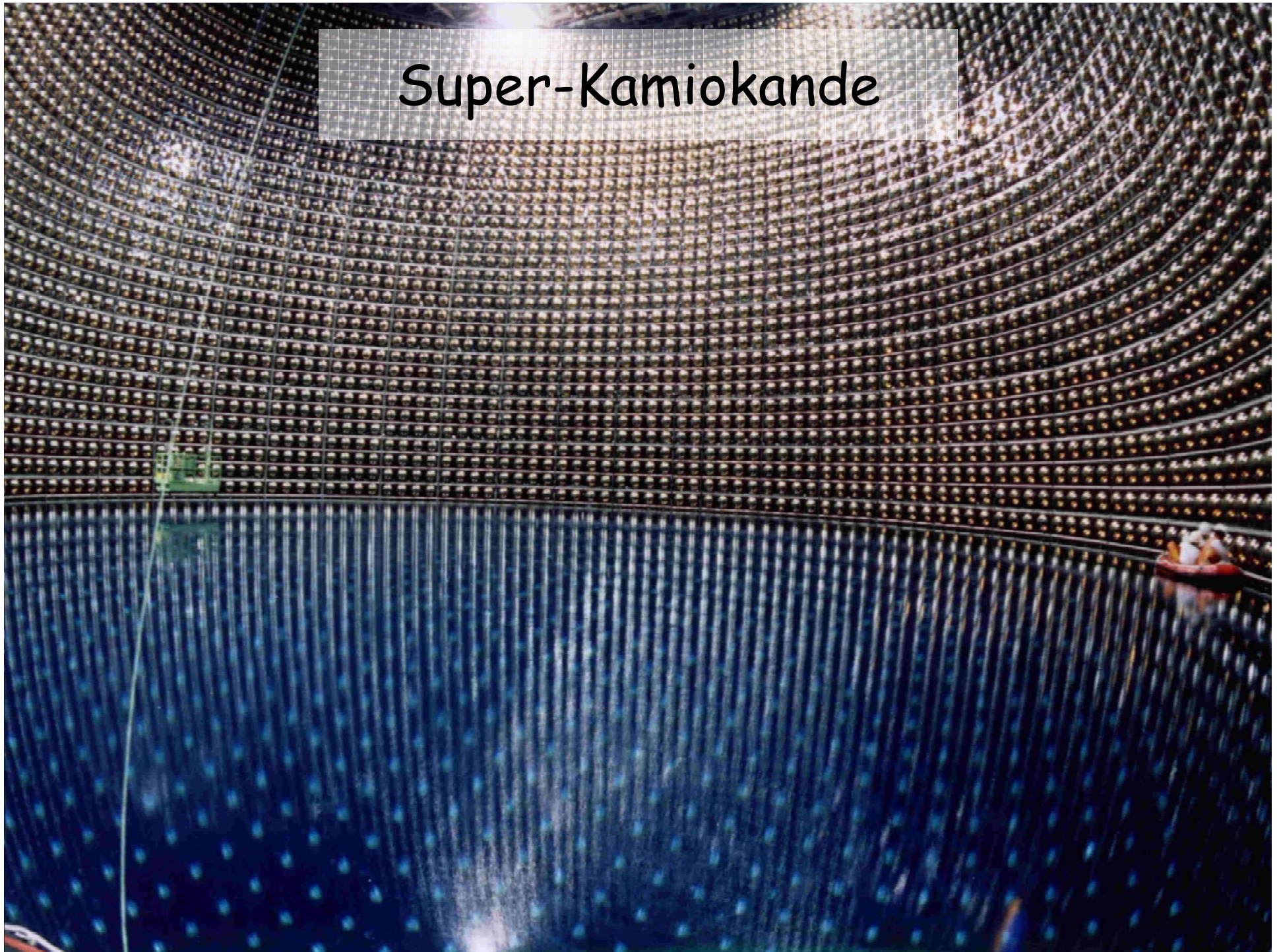



Super-Kamiokande

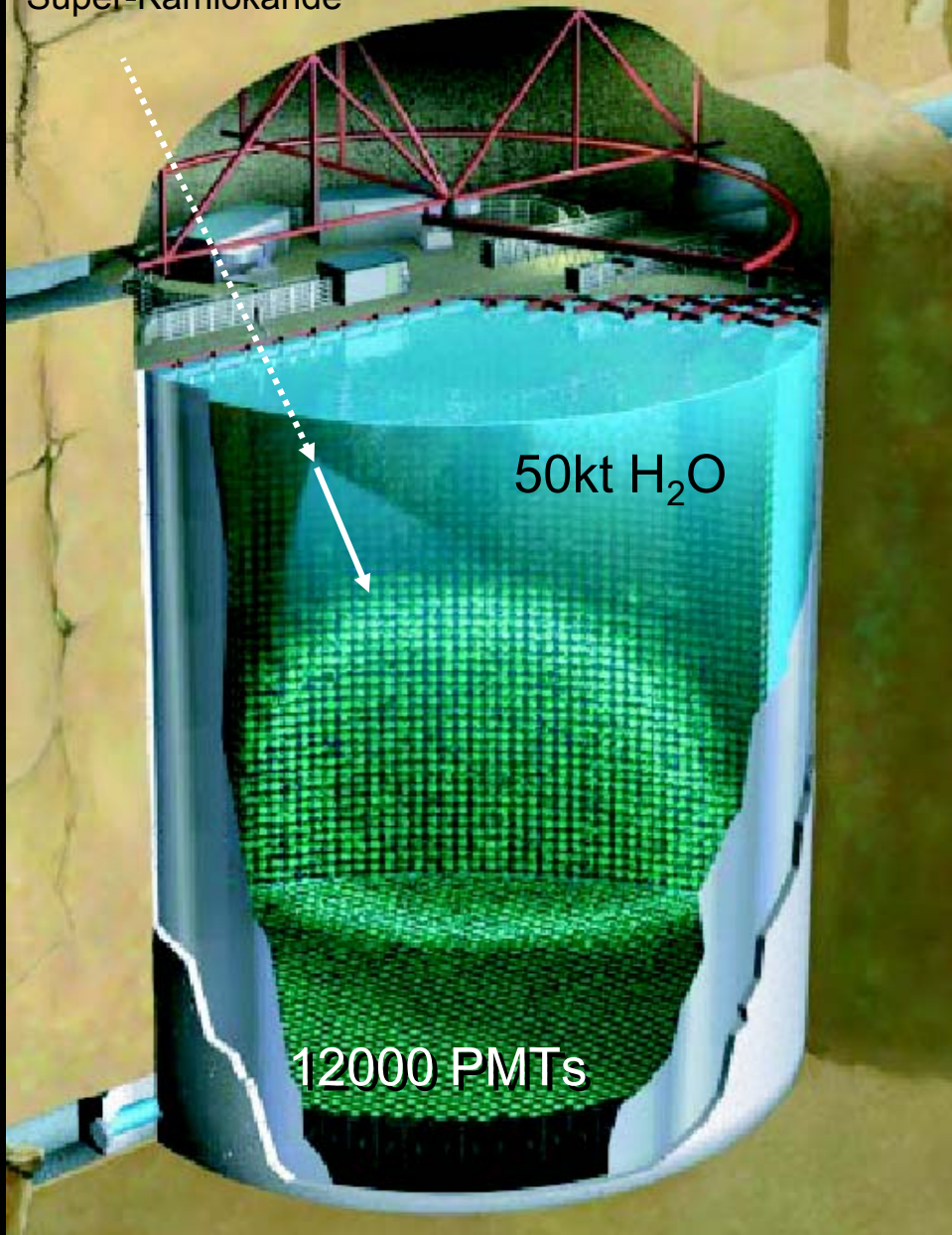

electron event

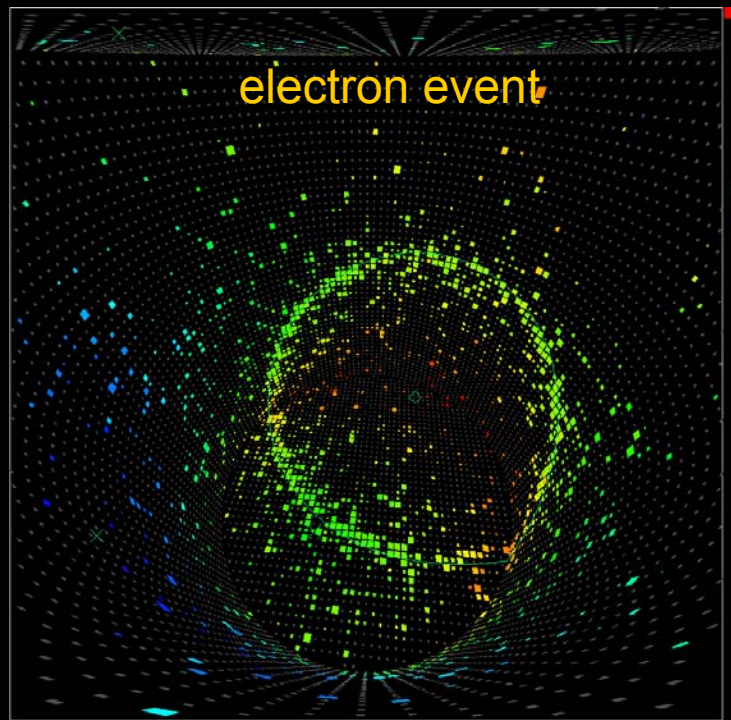

myon event

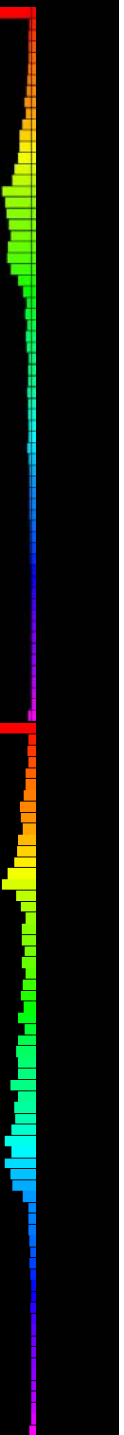
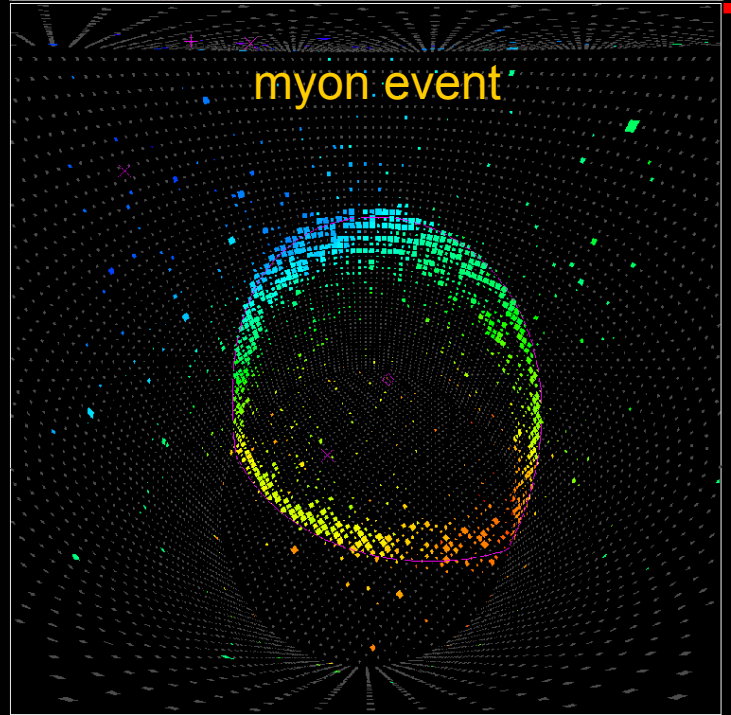

SuperK - atmospheric neutrinos

e-like events

μ -like events

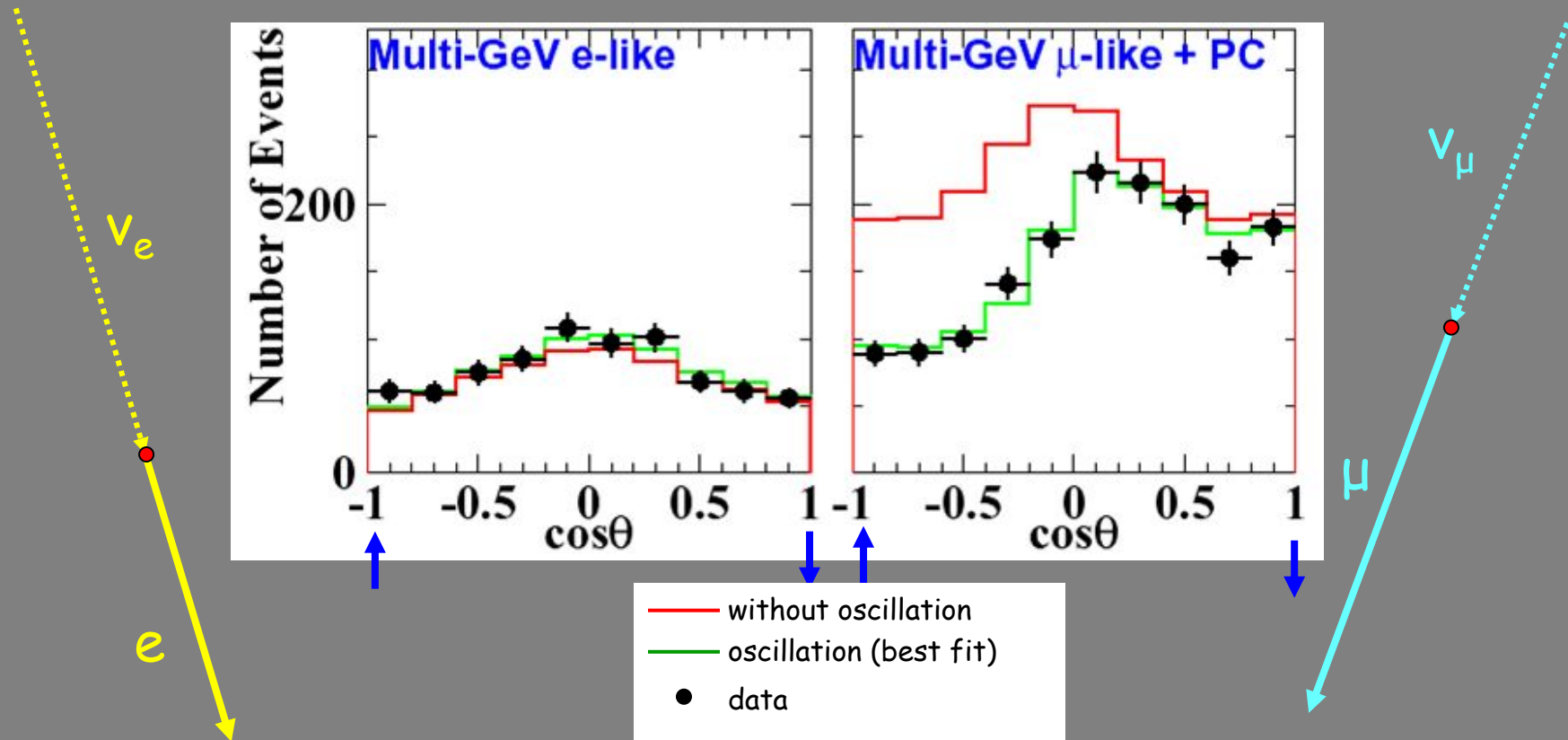

Full SK-I data set, 90% CL (PRD71 (2005) 112005):

$$\sin^2 2\theta > 0.92$$

$$1.5 \cdot 10^{-3} \text{ eV}^2 < \Delta m^2 < 3.4 \cdot 10^{-3} \text{ eV}^2$$

How to make Neutrino beams ($E_\nu \approx 1\text{GeV}-100\text{GeV}$)

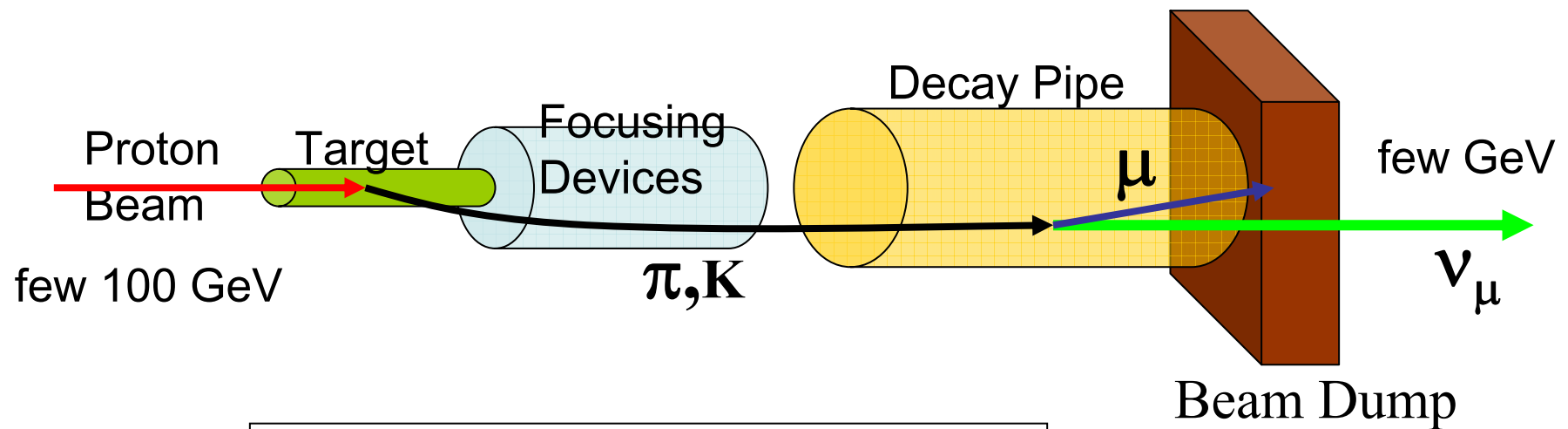

Beam composition (typical example):

- dominantly ν_μ
- contamination from $\bar{\nu}_\mu$ ($\approx 6\%$), ν_e ($\approx 0.7\%$), $\bar{\nu}_e$ ($\approx 0.2\%$)
- $\nu_\tau \lesssim 10^{-6}$



OPERA

Neutrino beam (ν_μ) from CERN to Gran Sasso Underground Lab (Italy)

ν_τ Appearance!

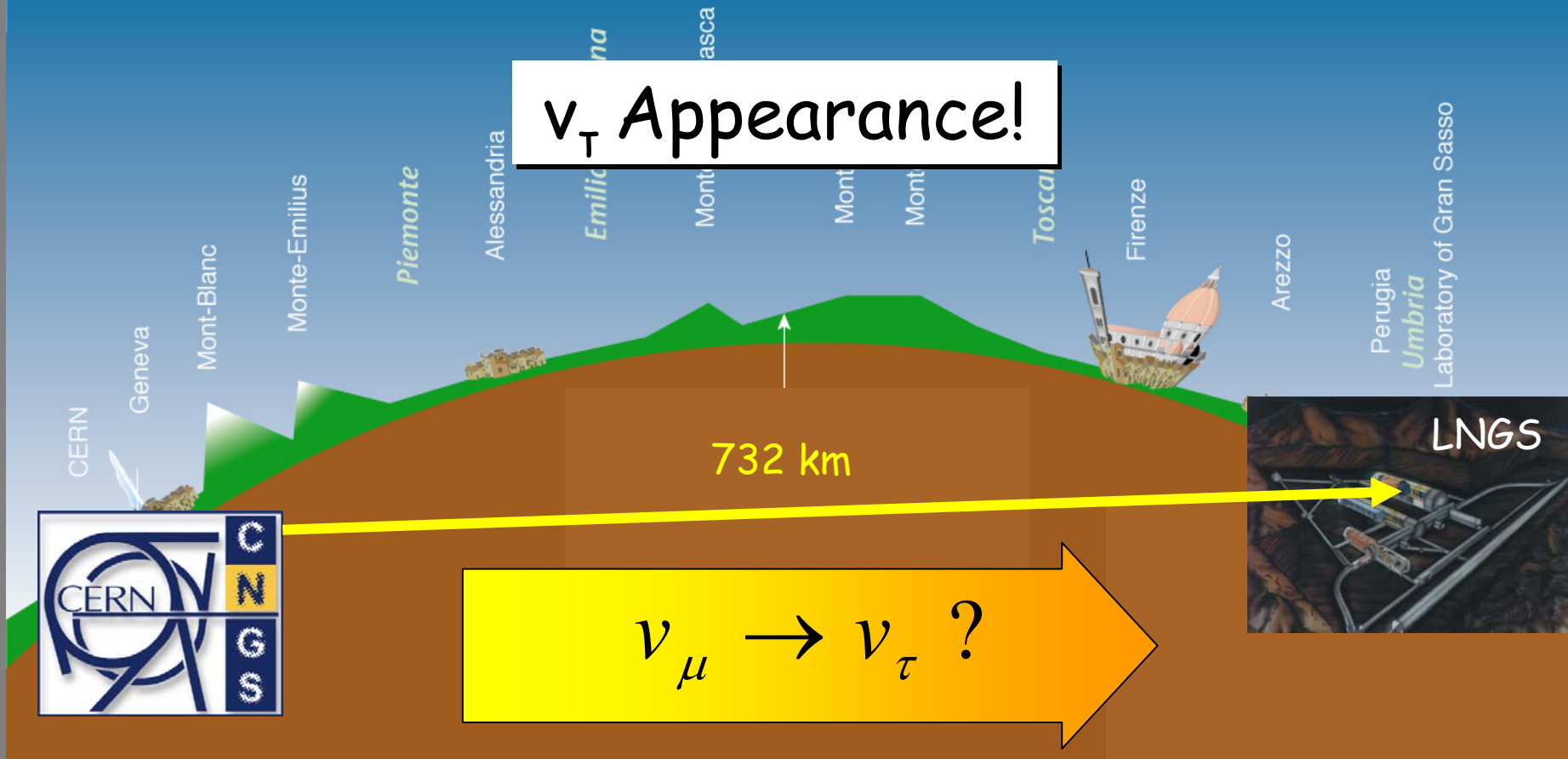

Started in june 2008, running...



OPERA: CNGS beam

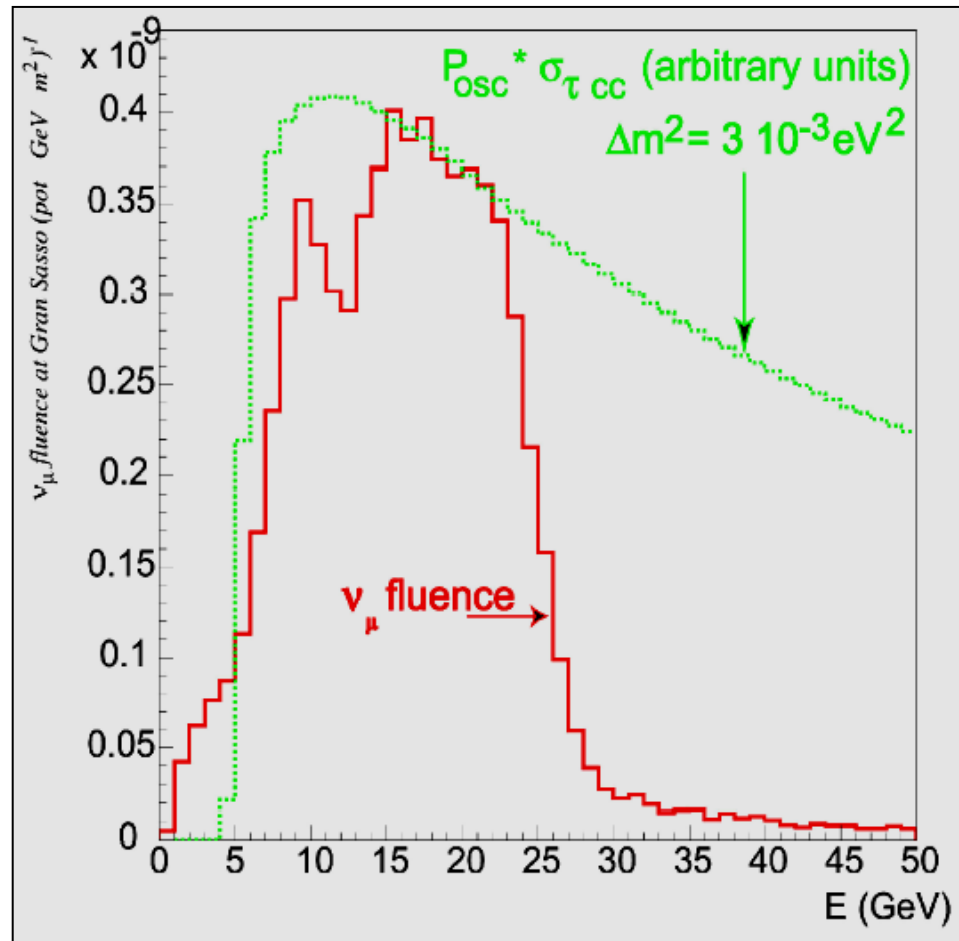

$$\langle E_\nu \rangle = 17 \text{ GeV}$$

$$\bar{\nu}_\mu / \nu_\mu = 4\%$$

$$(\bar{\nu}_e + \nu_e) / \nu_\mu = 0.87\%$$

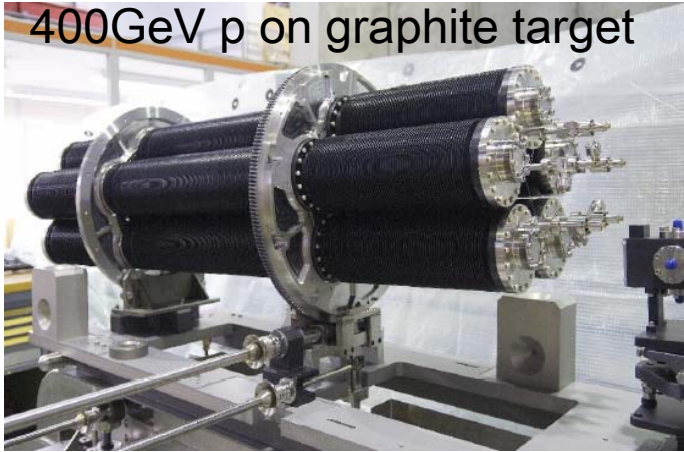

$4.5 \cdot 10^{19} \text{ pot/year}$



Querschnitt des Neutrinostrahls

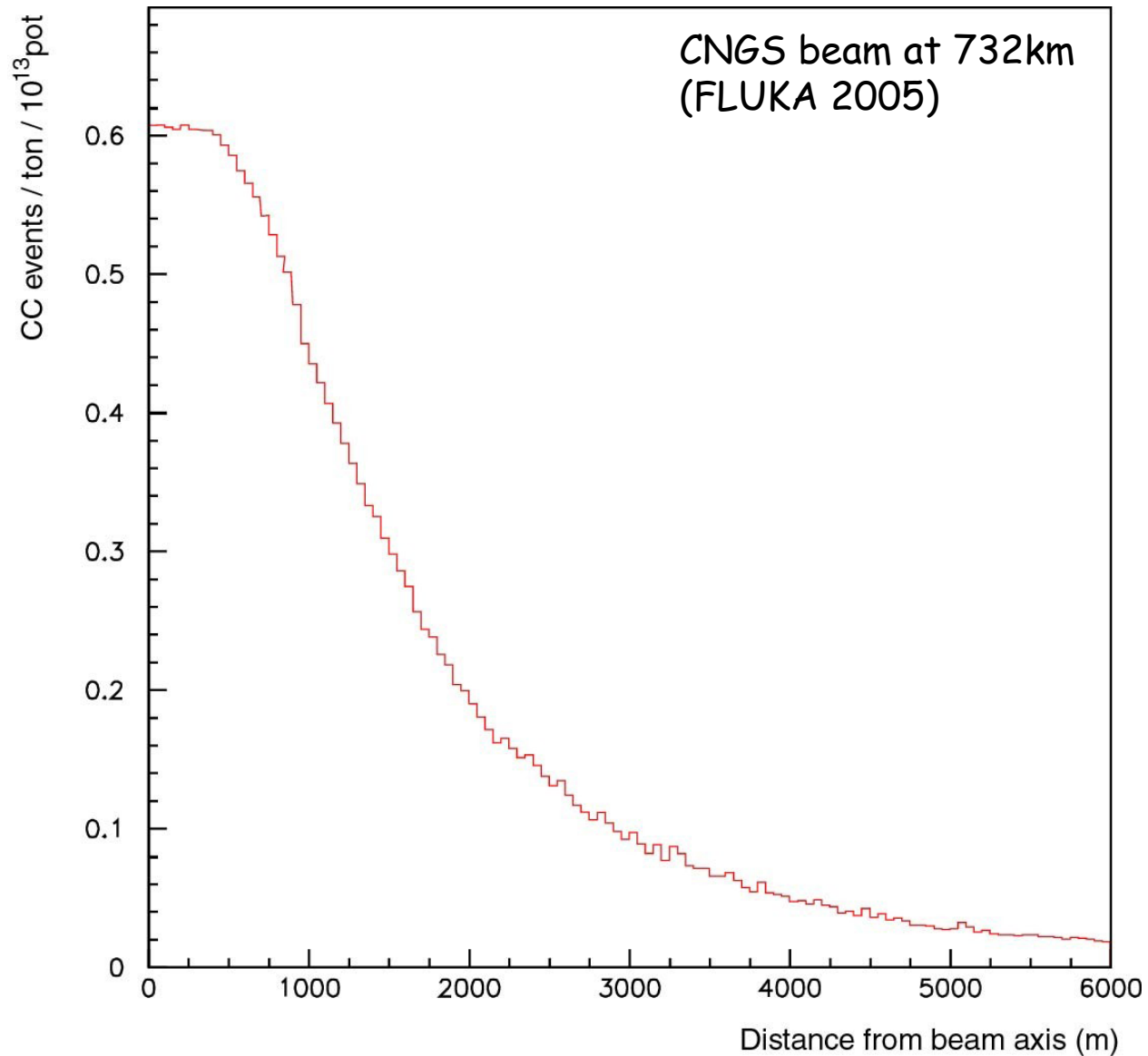



OPERA: Detection of ν_τ

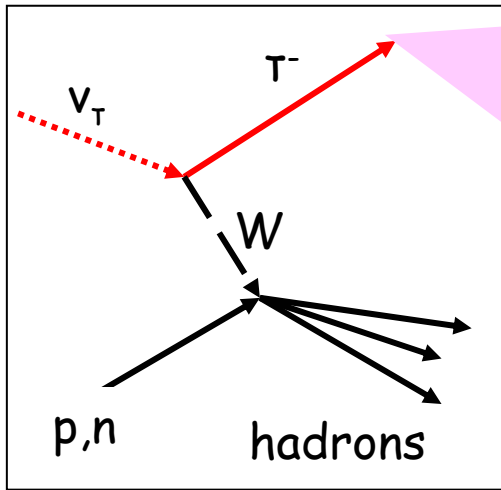

τ -decay:

- $\tau^- \rightarrow \mu^- + \bar{\nu}_\mu + \nu_\tau$ 18%
- $\tau^- \rightarrow e^- + \bar{\nu}_e + \nu_\tau$ 18%
- $\tau^- \rightarrow \pi^- (n\pi^0) + \nu_\tau$ 48%
- $\tau^- \rightarrow \pi^- \pi^- \pi^+ (n\pi^0) + \nu_\tau$ 15%

Typical topology of τ -decay:
"Kink" within 1mm from vertex

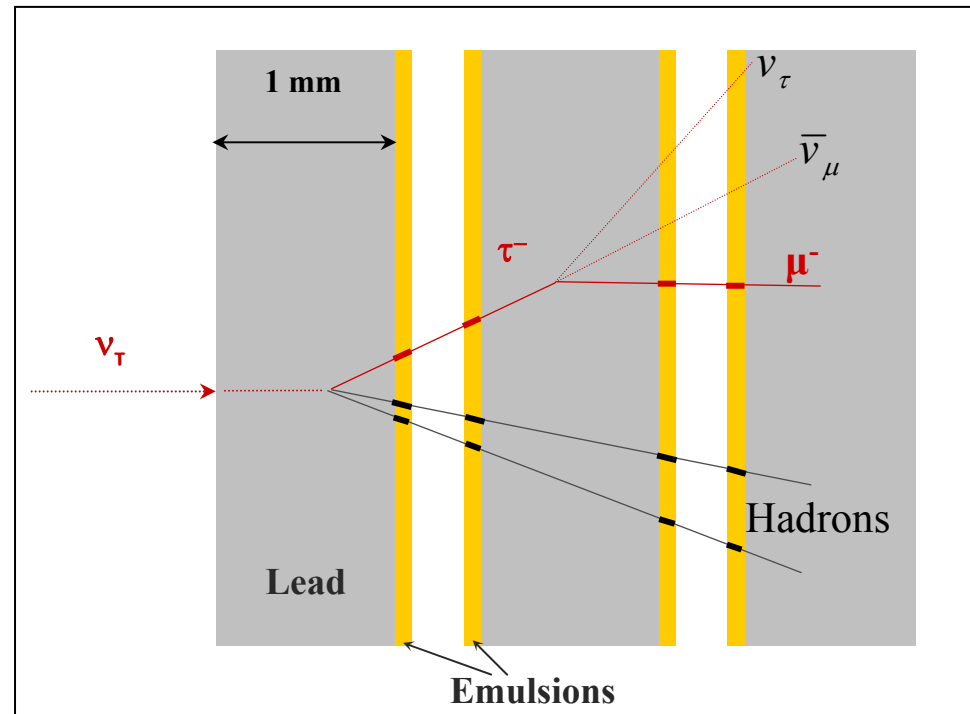



OPERA Target: Lead/Emulsion Bricks

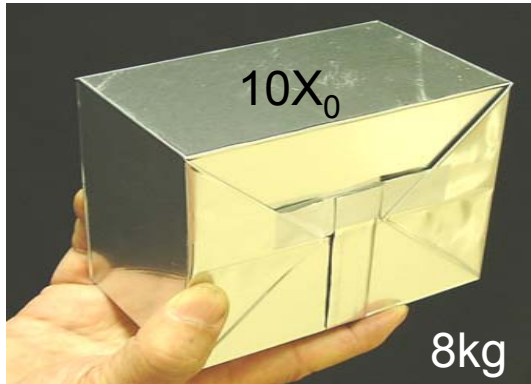

Lead/Emulsion Brick
(total ≈ 200000)

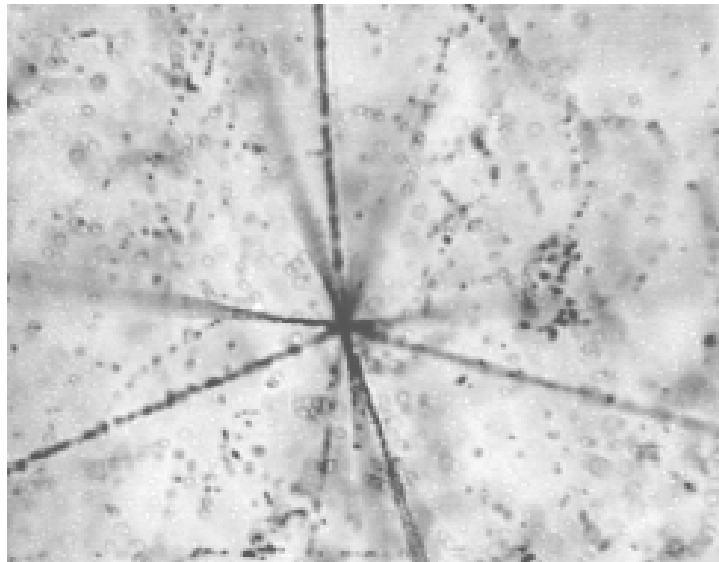
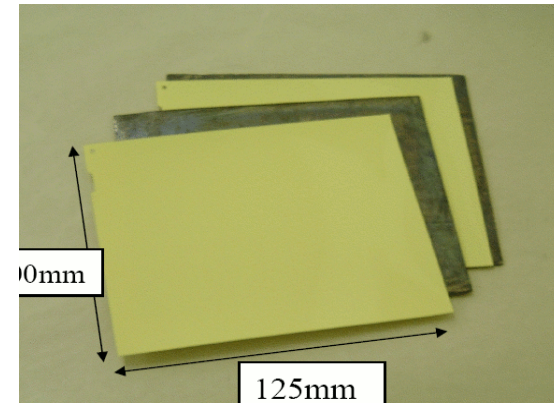
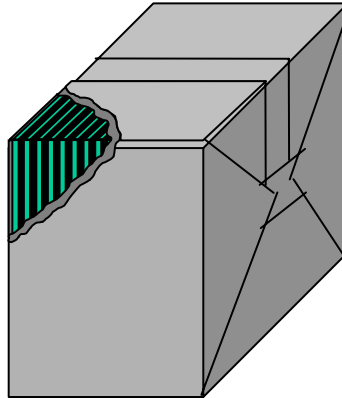

Scanning

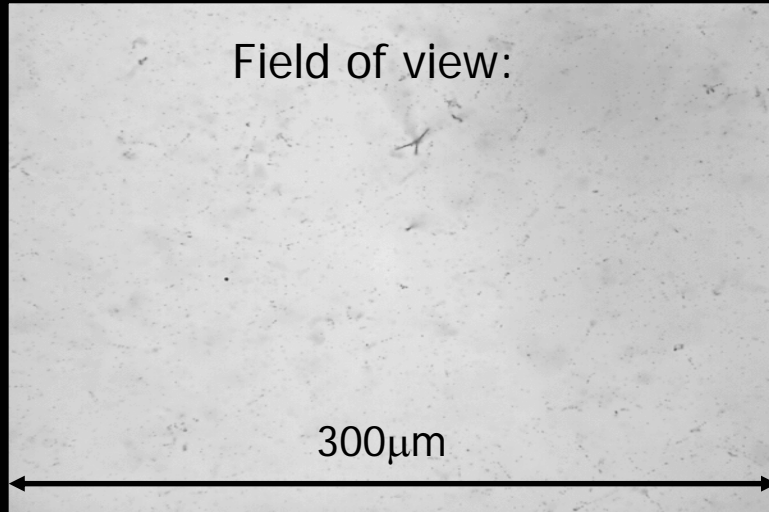

2d image: 16 tomographic images

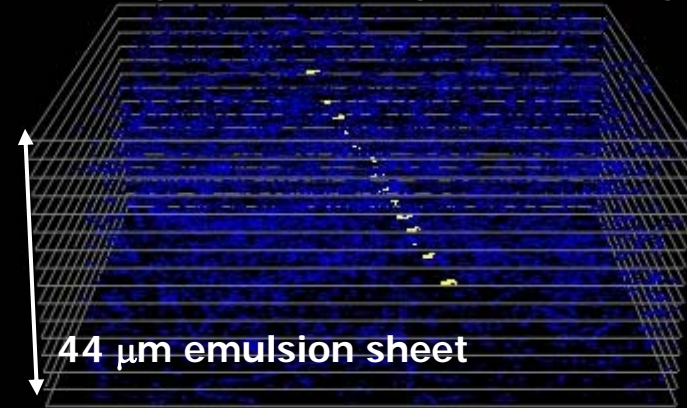

Vertex reconstruction & kinematical analysis

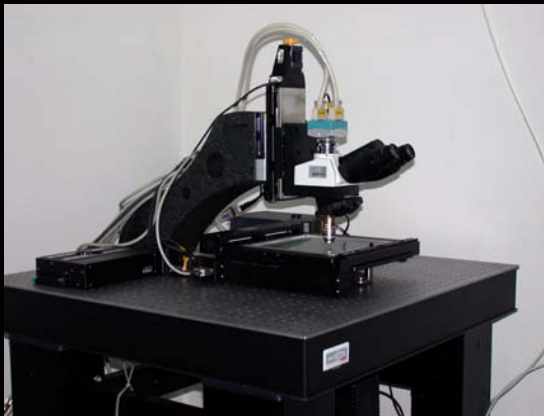
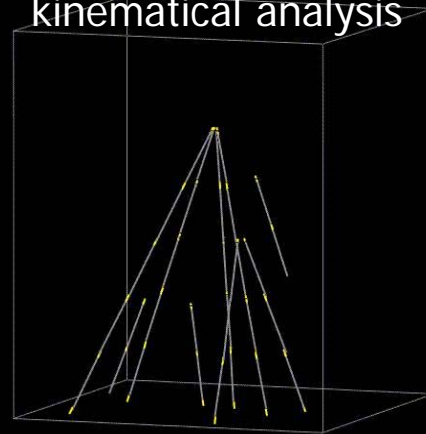



OPERA - Detector

Supermodule 1



Target Region:

- Target Tracker (Scintillator)
- Lead/Emulsion Bricks (100.000 per Supermodule)



OPERA - Detector

Supermodule 1

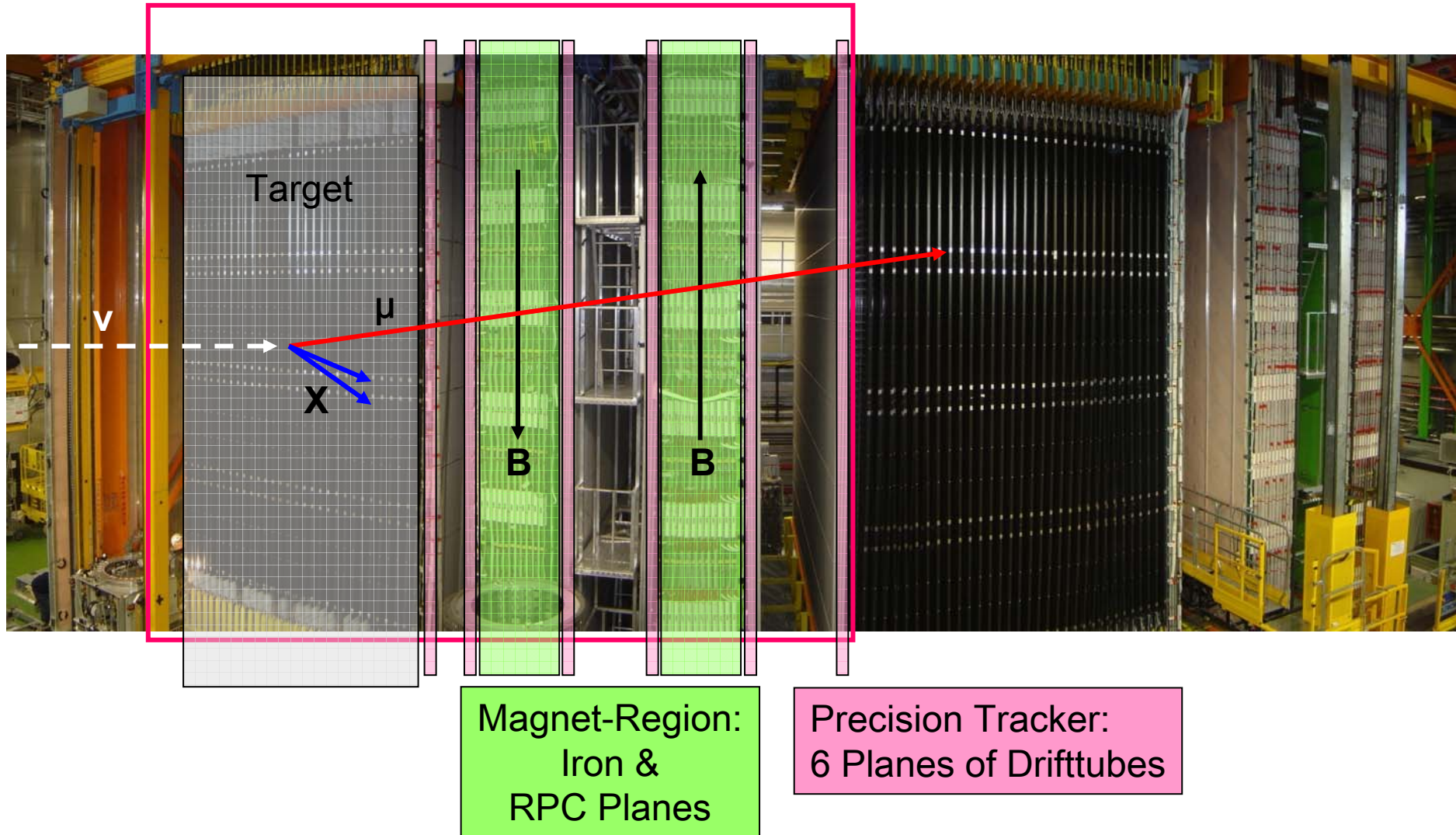



OPERA - Brick Manipulating System

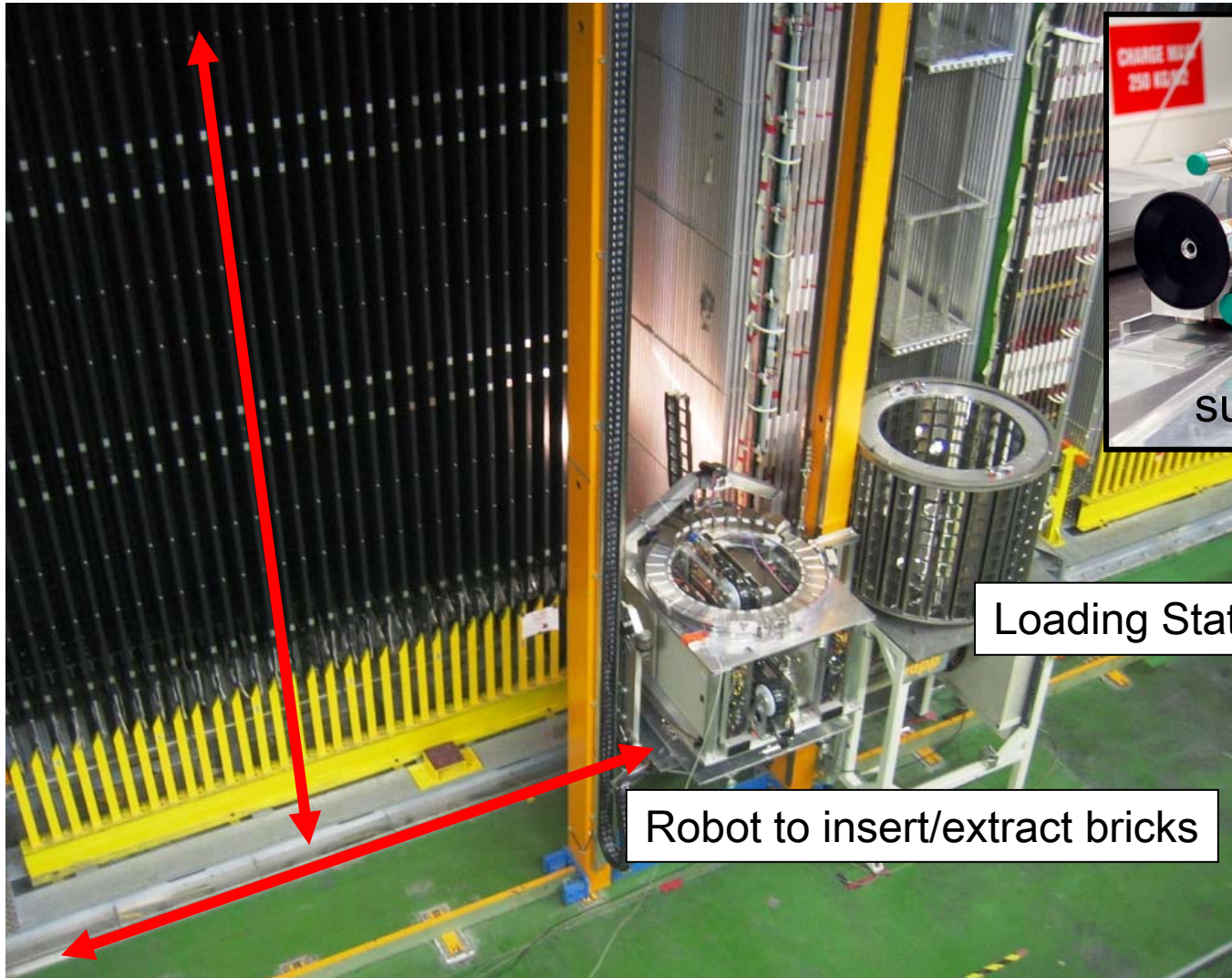

suction cup vehicle

Loading Station

Robot to insert/extract bricks



OPERA Sensitivity

OPERA: 6200 ν_μ CC+NC /year
19 ν_τ CC/year (for $\Delta m^2 = 2 \cdot 10^{-3} \text{ eV}^2$)

	$\Delta m^2 = 1.9 \times 10^{-3} \text{ eV}^2$	$\Delta m^2 = 2.4 \times 10^{-3} \text{ eV}^2$	$\Delta m^2 = 3.0 \times 10^{-3} \text{ eV}^2$	BKGD
ν_τ in OPERA	6.6	10.5	16.4	0.7

exposure: 5 years @ 4.5×10^{19} pot / year



OPERA Event (ν_μ CC)

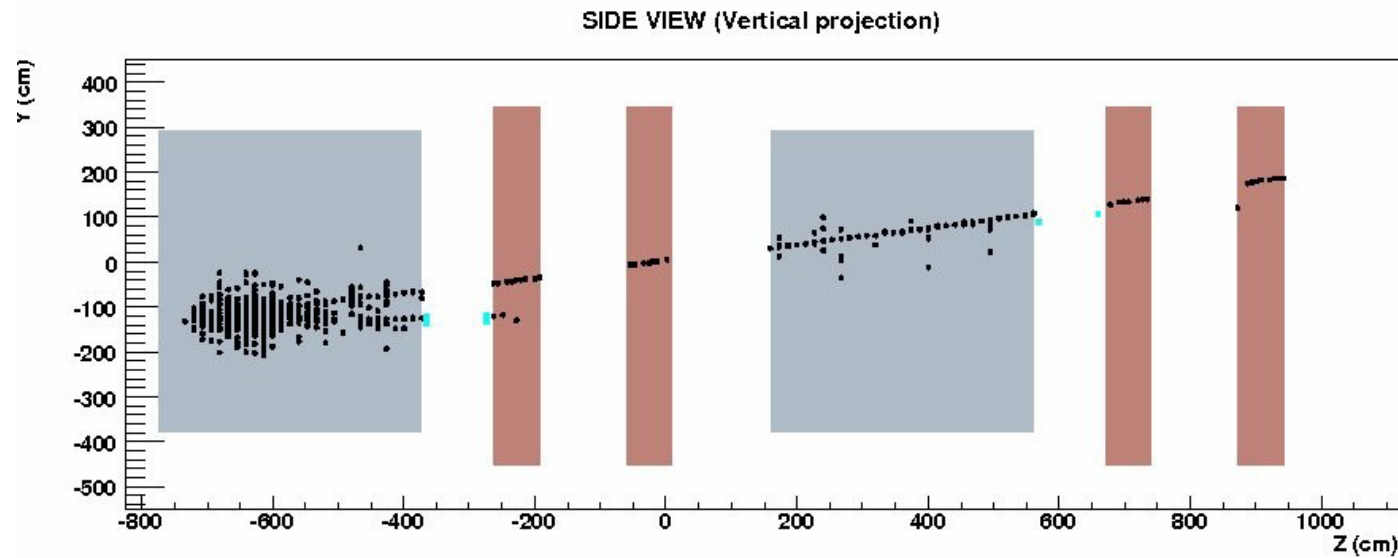
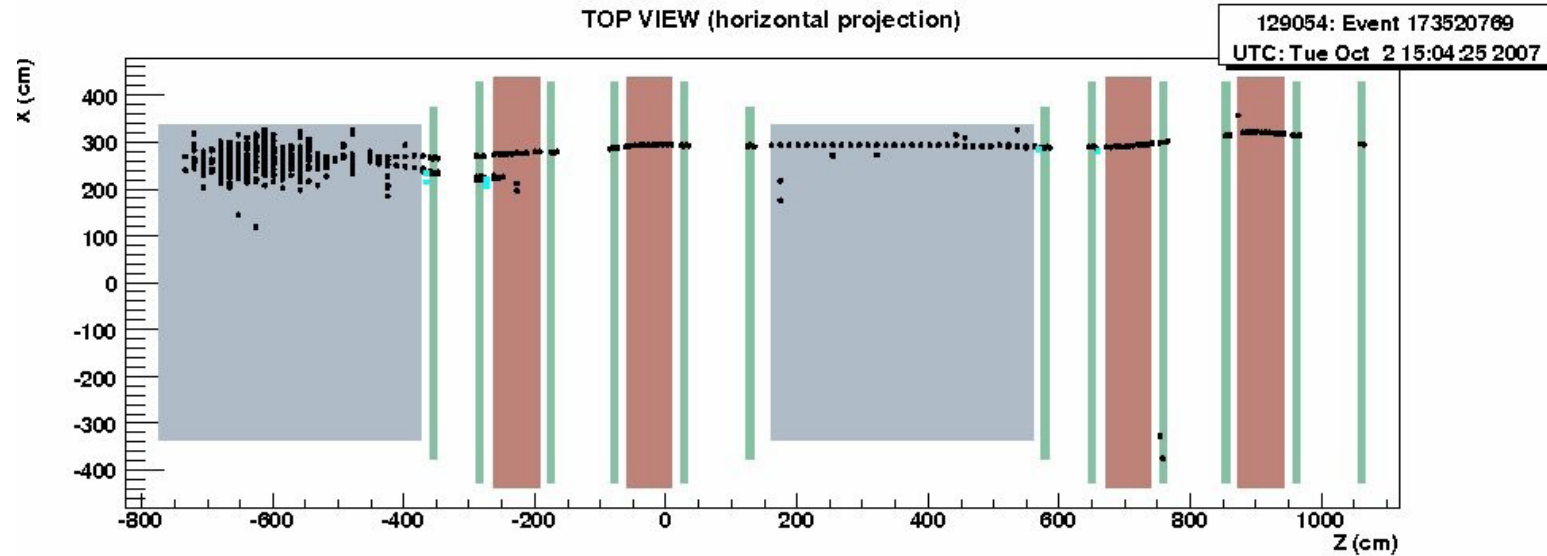



Event 180718369

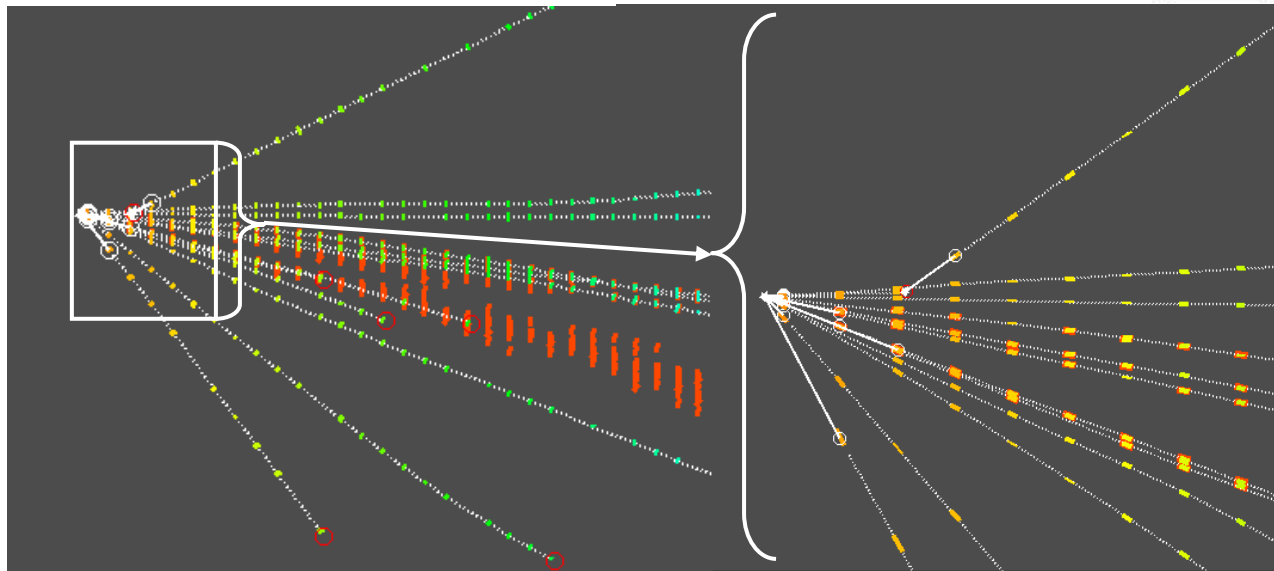
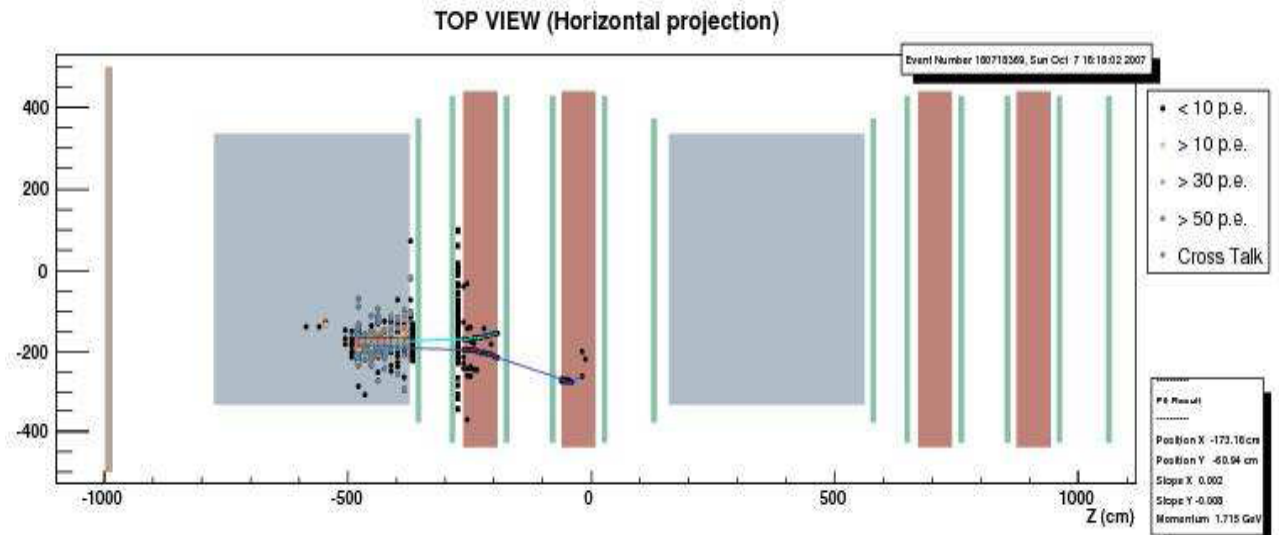

Secondary Vertex:

- daughter momentum = $3.9^{+1.7}_{-0.9}$ GeV
- kink angle = 0.204 rad
- flight length = 3247 μm
- PT = 796 MeV
- $PT_{\text{MIN}} = 606$ MeV (90% C.L.)

Kink probably from decaying D-Meson (contains c-quark).

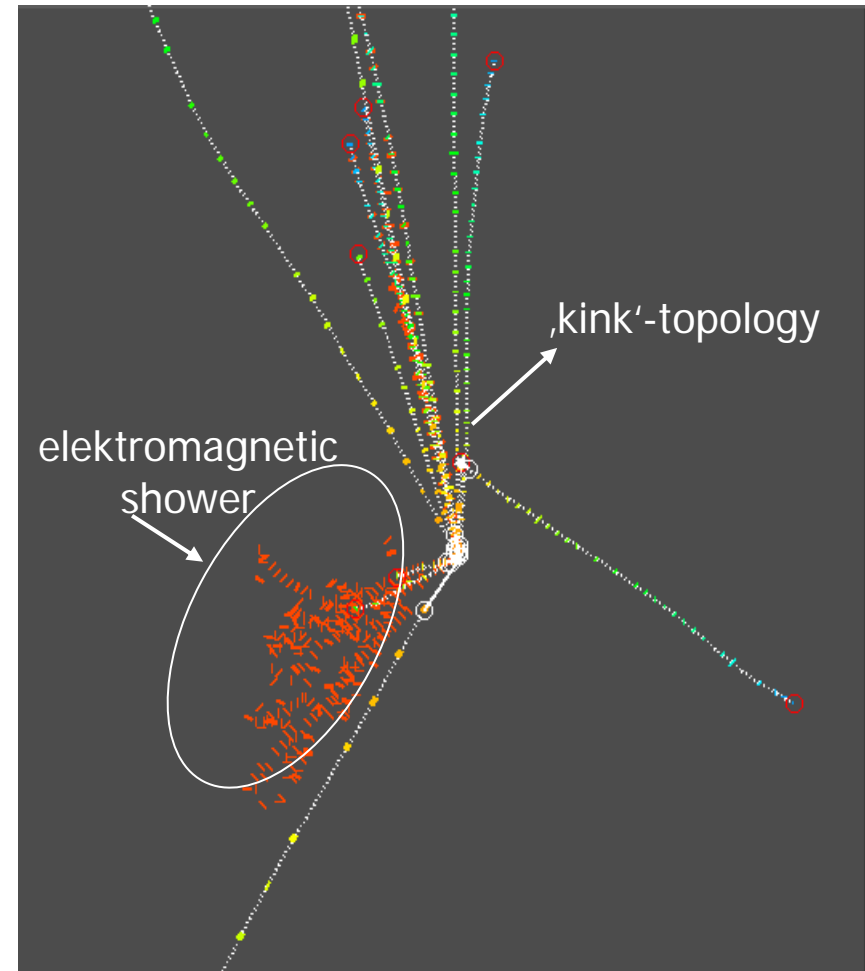



OPERA summary

- Experiment running since June 2008
- Detector is working fine (Charm candidates identified)
- Brick analysis is ongoing
- In total ~10 identified tau-neutrino events expected
- So far no tau-neutrino has been found (0.6 expected)

OPERA is awaiting its first tau-neutrino!

Now we look at electron neutrinos

- Electron neutrino sources are:
The Sun (neutrinos)
Nuclear reactors (anti-neutrinos)
- These neutrinos have energies of a few MeV
- completely different detection techniques necessary!

Solar Neutrinos ($E_\nu \approx \text{MeV}$)

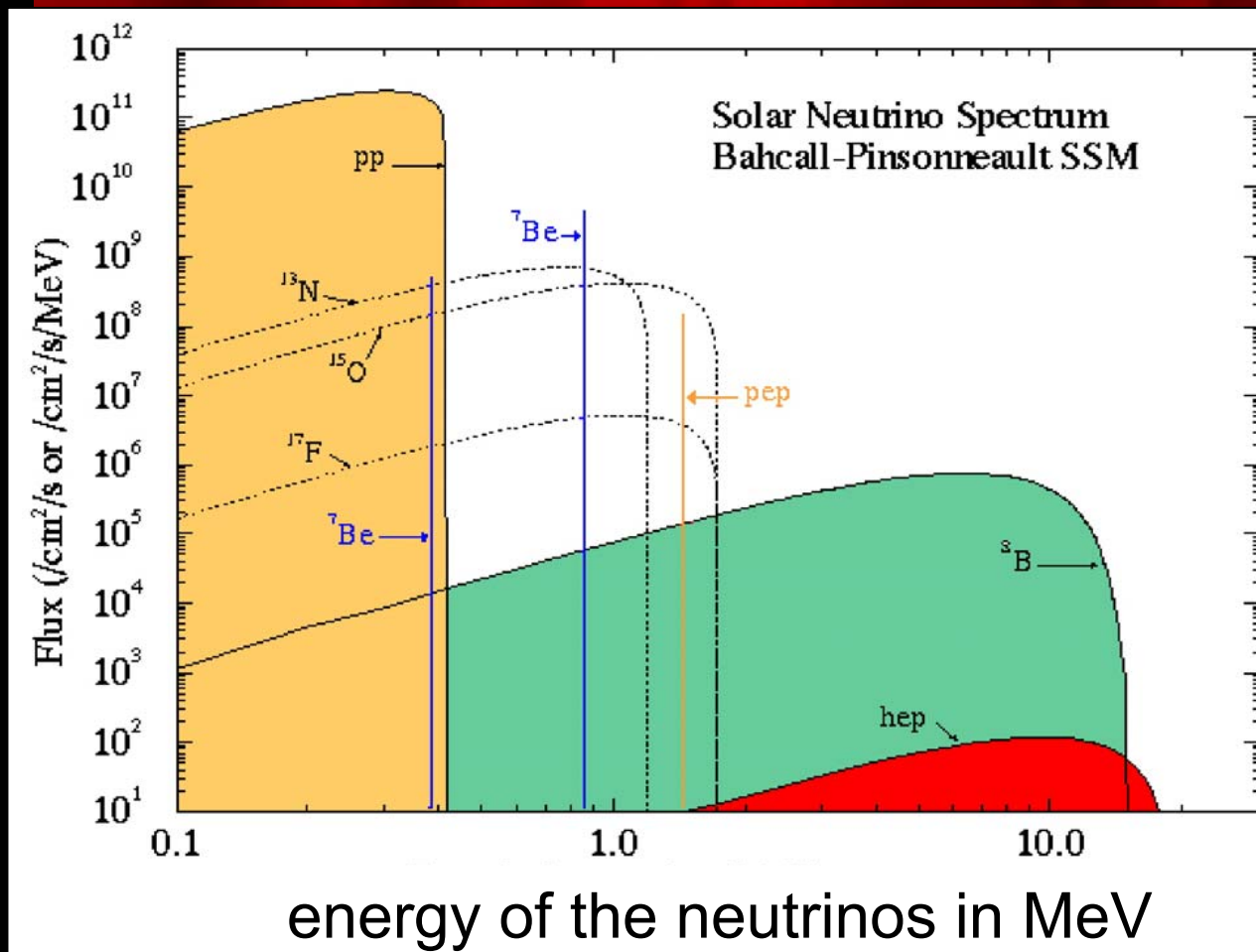
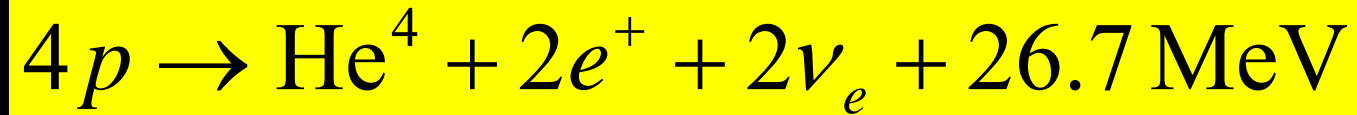

neutrino production in the sun

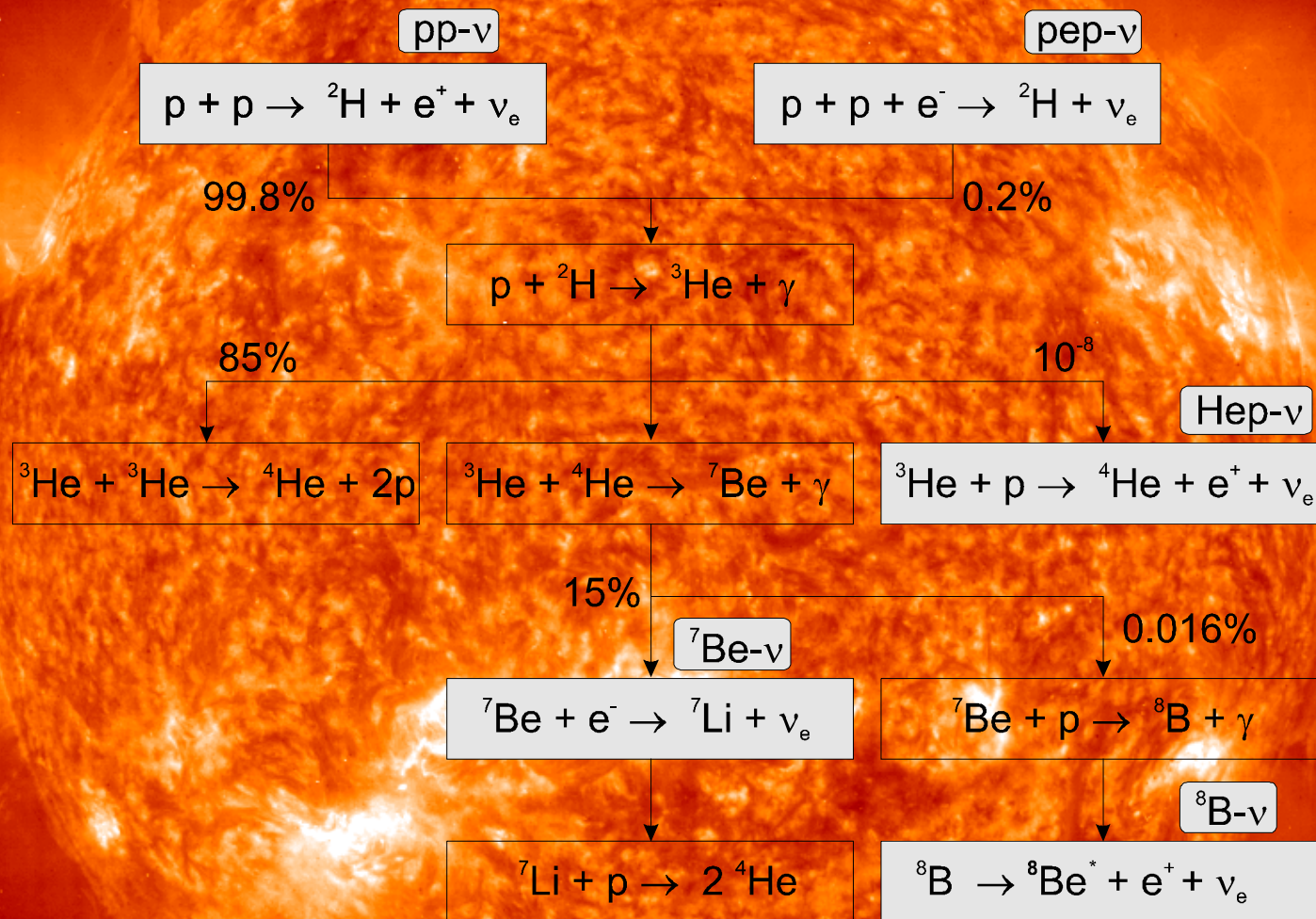

pp- I

pp- II

pp- III

Energy Production in Stars

Bethe 1939

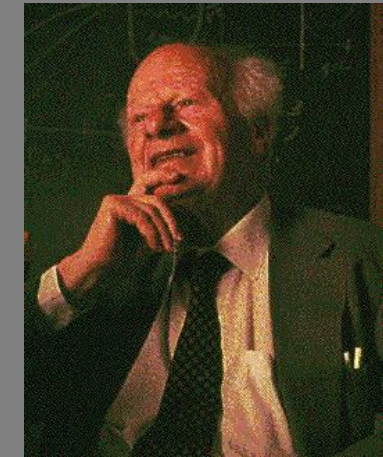

pp chain
CNO cycle

MARCH 1, 1939

PHYSICAL REVIEW

VOLUME 55

Energy Production in Stars*

H. A. BETHE

Cornell University, Ithaca, New York

(Received September 7, 1938)

It is shown that the *most important source of energy in ordinary stars is the reactions of carbon and nitrogen with protons*. These reactions form a cycle in which the original nucleus is reproduced, *viz.* $C^{12}+H=N^{13}$, $N^{13}=C^{13}+\epsilon^+$, $C^{13}+H=N^{14}$, $N^{14}+H=O^{15}$, $O^{15}=N^{15}+\epsilon^+$, $N^{15}+H=C^{12}+He^4$. Thus carbon and nitrogen merely serve as catalysts for the combination of four protons (and two electrons) into an α -particle (§7).

The carbon-nitrogen reactions are unique in their cyclical character (§8). For all nuclei lighter than carbon, reaction with protons will lead to the emission of an α -particle so that the original nucleus is permanently destroyed. For all nuclei heavier than fluorine, only radiative capture of the protons occurs, also destroying the original nucleus. Oxygen and fluorine reactions mostly lead back to nitrogen. Besides, these heavier nuclei react much more slowly than C and N and are therefore unimportant for the energy production.

The agreement of the carbon-nitrogen reactions with observational data (§7, 9) is excellent. In order to give the correct energy evolution in the sun, the central temperature of the sun would have to be 18.5 million degrees while

integration of the Eddington equations gives 19. For the brilliant star Y Cygni the corresponding figures are 30 and 32. This good agreement holds for all bright stars of the main sequence, but, of course, not for giants.

For fainter stars, with lower central temperatures, the reaction $H+H=D+\epsilon^+$ and the reactions following it, are believed to be mainly responsible for the energy production. (§10)

It is shown further (§5-6) that *no elements heavier than He⁴ can be built up in ordinary stars*. This is due to the fact, mentioned above, that all elements up to boron are disintegrated by proton bombardment (α -emission!) rather than built up (by radiative capture). The instability of Be⁸ reduces the formation of heavier elements still further. The production of neutrons in stars is likewise negligible. The heavier elements found in stars must therefore have existed already when the star was formed.

Finally, the suggested mechanism of energy production is used to draw conclusions about astrophysical problems, such as the mass-luminosity relation (§10), the stability against temperature changes (§11), and stellar evolution (§12).

§1. INTRODUCTION

THE progress of nuclear physics in the last few years makes it possible to decide rather definitely which processes can and which cannot occur in the interior of stars. Such decisions will be attempted in the present paper, the discussion being restricted primarily to main sequence stars. The results will be at variance with some current hypotheses.

The first main result is that, under present conditions, no elements heavier than helium can be built up to any appreciable extent. Therefore we must assume that the heavier elements were built up *before* the stars reached their present state of temperature and density. No attempt will be made at speculations about this previous state of stellar matter.

The energy production of stars is then due entirely to the combination of four protons and two electrons into an α -particle. This simplifies the discussion of stellar evolution inasmuch as

* Awarded an A. Cressy Morrison Prize in 1938, by the New York Academy of Sciences.

the amount of heavy matter, and therefore the opacity, does not change with time.

The combination of four protons and two electrons can occur essentially only in two ways. The first mechanism starts with the combination of two protons to form a deuteron with positron emission, *viz.*

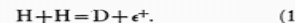

The deuteron is then transformed into He⁴ by further capture of protons; these captures occur very rapidly compared with process (1). The second mechanism uses carbon and nitrogen as catalysts, according to the chain reaction

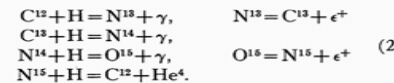

The catalyst C¹² is reproduced in all cases except about one in 10,000, therefore the abundance of carbon and nitrogen remains practically unchanged (in comparison with the change of the number of protons). The two reactions (1) and

The combination of four protons and two electrons can occur essentially only in two ways. The first mechanism starts with the combination of two protons to form a deuteron with positron emission, *viz.*

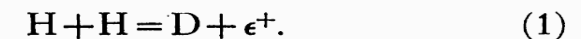

The deuteron is then transformed into He⁴ by further capture of protons; these captures occur very rapidly compared with process (1). The second mechanism uses carbon and nitrogen as catalysts, according to the chain reaction

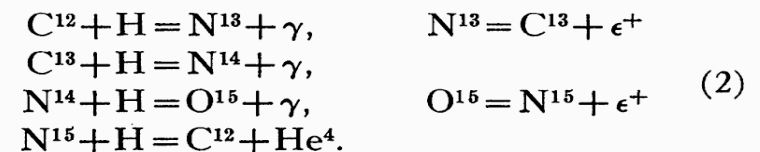

Solar Neutrinos

Bahcall, Davis 1964

VOLUME 12, NUMBER 11

PHYSICAL REVIEW LETTERS

16 MARCH 1964

SOLAR NEUTRINOS. I. THEORETICAL*

John N. Bahcall

California Institute of Technology, Pasadena, California

(Received 6 January 1964)

The principal energy source for main-sequence stars like the sun is believed to be the fusion, in the deep interior of the star, of four protons to form an alpha particle.¹ The fusion reactions are thought to be initiated by the sequence ${}^1\text{H}(\rho, e^+\nu){}^2\text{H}(\rho, \gamma){}^3\text{He}$ and terminated by the following sequences: (i) ${}^3\text{He}({}^3\text{He}, 2p){}^4\text{He}$; (ii) ${}^3\text{He}(\alpha, \gamma){}^7\text{Be}$ ($e^-\nu$) ${}^7\text{Li}(\rho, \alpha){}^4\text{He}$; and (iii) ${}^3\text{He}(\alpha, \gamma){}^7\text{Be}(\rho, \gamma){}^8\text{B}$ ($e^+\nu$) ${}^8\text{Be}(\alpha){}^4\text{He}$. No direct evidence for the existence of nuclear reactions in the interiors of stars has yet been obtained because the mean free path for photons emitted in the center of a

star is typically less than 10^{-10} of the radius of the star. Only neutrinos, with their extremely small interaction cross sections, can enable us to see into the interior of a star and thus verify directly the hypothesis of nuclear energy generation in stars.

The most promising method² for detecting solar neutrinos is based upon the endothermic reaction ($Q = 0.81$ MeV) ${}^{37}\text{Cl}(\nu_{\text{solar}}, e^-){}^{37}\text{Ar}$, which was first discussed as a possible means of detecting neutrinos by Pontecorvo³ and Alvarez.⁴ In this note, we predict the number of absorptions of

SOLAR NEUTRINOS. II. EXPERIMENTAL*

Raymond Davis, Jr.

Chemistry Department, Brookhaven National Laboratory, Upton, New York

(Received 6 January 1964)

The prospect of observing solar neutrinos by means of the inverse beta process ${}^{37}\text{Cl}(\nu, e^-){}^{37}\text{Ar}$ induced us to place the apparatus previously described¹ in a mine and make a preliminary search. This experiment served to place an upper limit on the flux of extraterrestrial neutrinos. These results will be reported, and a discussion will be given of the possibility of extending the sensitivity of the method to a degree capable of measuring the solar neutrino flux calculated by Bahcall in the preceding paper.²

The apparatus consists of two 500-gallon tanks of perchlorethylene, C_2Cl_4 , equipped with agitators and an auxiliary system for purging with helium. It is located in a limestone mine 2300 feet below the surface³ (1800 meters of water equivalent shielding, m. w. e.). Initially the tanks were swept completely free of air argon by purging the tanks with a stream of helium gas. ${}^{39}\text{Ar}$ carrier (0.10 cm³) was introduced and the tanks exposed for periods of four months or more to allow the 35-d ${}^{37}\text{Ar}$ activity to reach nearly the saturation value. Carrier argon along with any ${}^{37}\text{Ar}$ pro-

3 counts in 18 days is probably entirely due to the background activity. However, if one assumes that this rate corresponds to real events and uses the efficiencies mentioned, the upper limit of the neutrino capture rate in 1000 gallons of C_2Cl_4 is ≤ 0.5 per day or $\bar{\sigma} \leq 3 \times 10^{-34} \text{ sec}^{-1} ({}^{37}\text{Cl atom})^{-1}$. From this value, Bahcall² has set an upper limit on the central temperature of the sun and other relevant information.

On the other hand, if one wants to measure the solar neutrino flux by this method one must use a much larger amount of C_2Cl_4 , so that the expected ${}^{37}\text{Ar}$ production rate is well above the background of the counter, 0.2 count per day. Using Bahcall's expression,

$$\sum_{\nu} \rho_{\nu}(\text{solar}) \sigma_{\text{abs}} = (4 \pm 2) \times 10^{-35} \text{ sec}^{-1} ({}^{37}\text{Cl atom})^{-1},$$

then the expected solar neutrino captures in 100 000 gallons of C_2Cl_4 will be 4 to 11 per day, which is an order of magnitude larger than the counter background. On the basis of experience

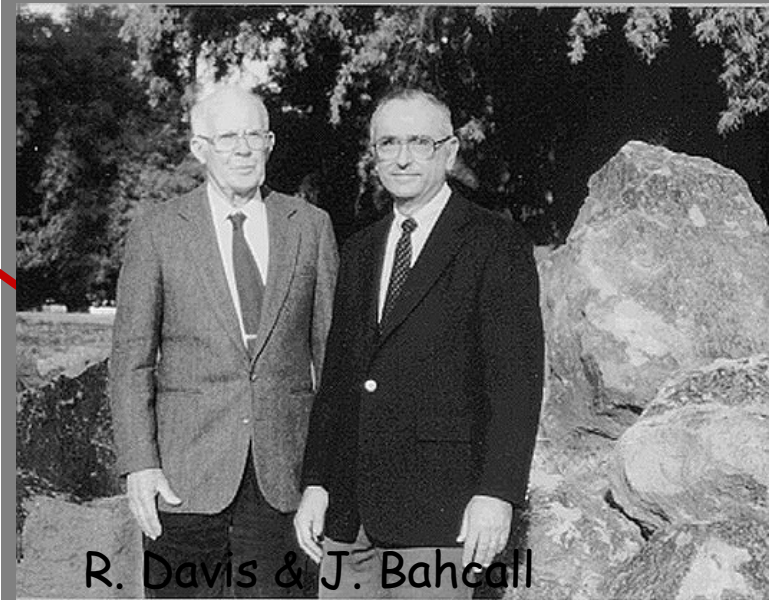

the star. Only neutrinos, with their extremely small interaction cross sections, can enable us to see into the interior of a star and thus verify directly the hypothesis of nuclear energy generation in stars.

Solar Neutrinos: "pioneering experiment"

Nobelprize 2002

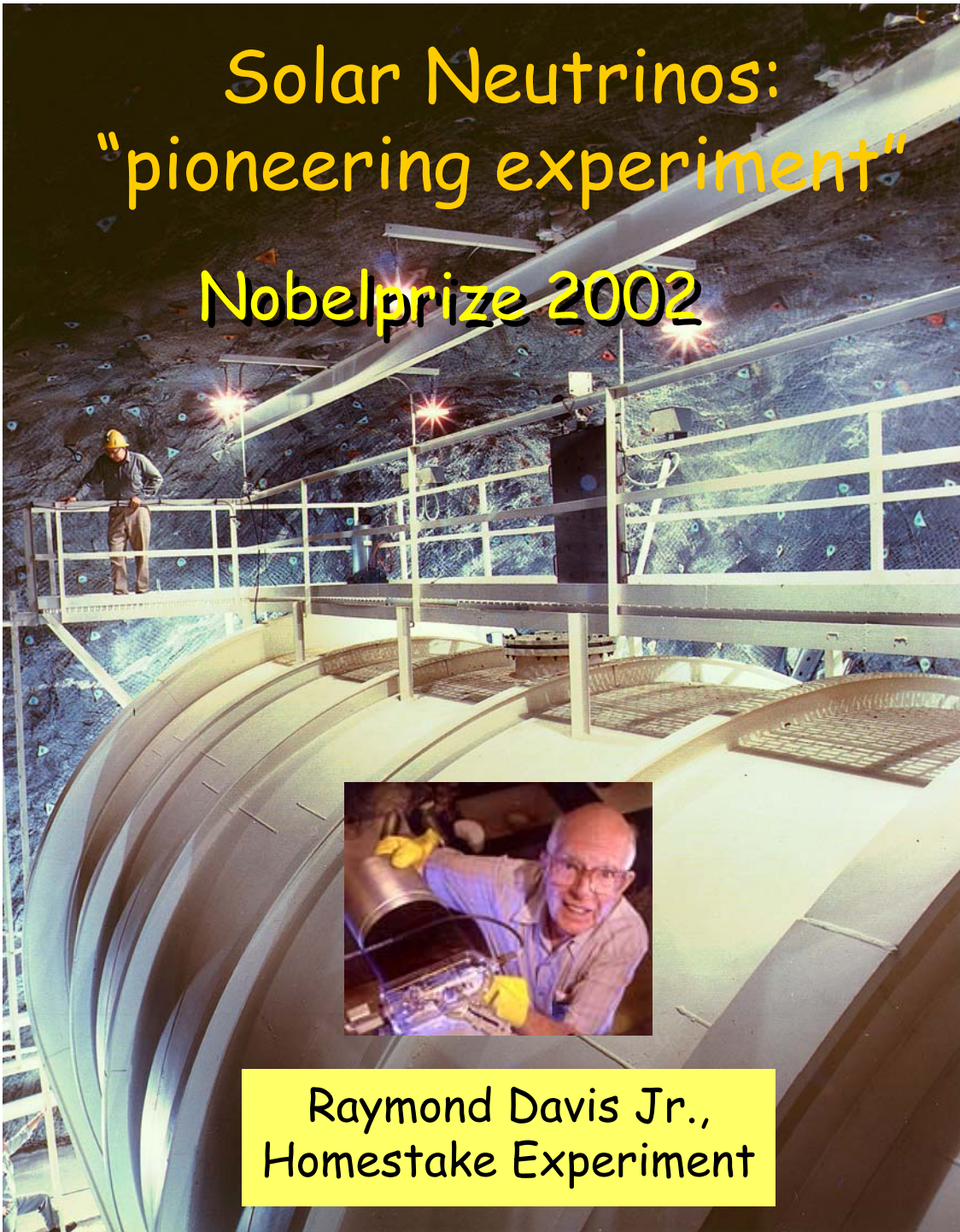

Raymond Davis Jr.,
Homestake Experiment

Since ≈ 1970

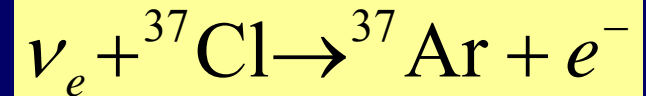

$$E_\nu > 814 \text{ keV}$$

$$R_{\text{exp}} = 0.34 \times \text{SSM}$$

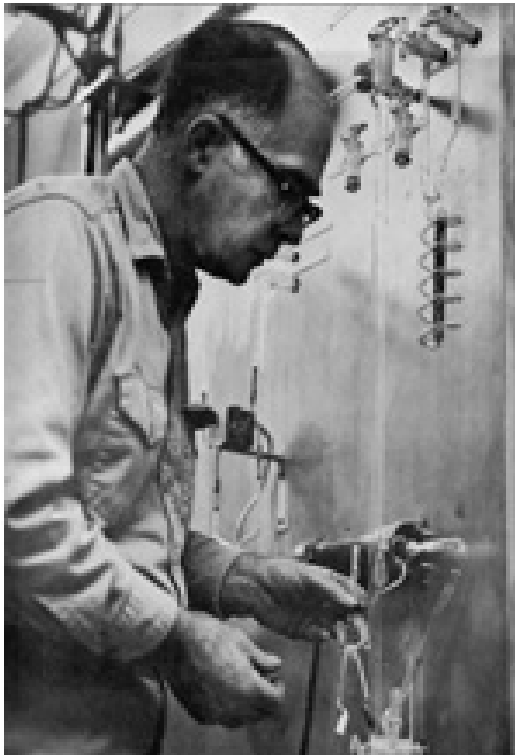

Ar – Counting:

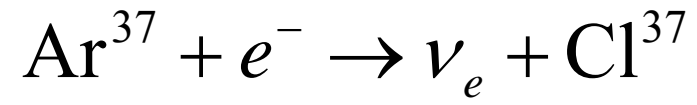

$T_{1/2} = 35 \text{ Tage}$

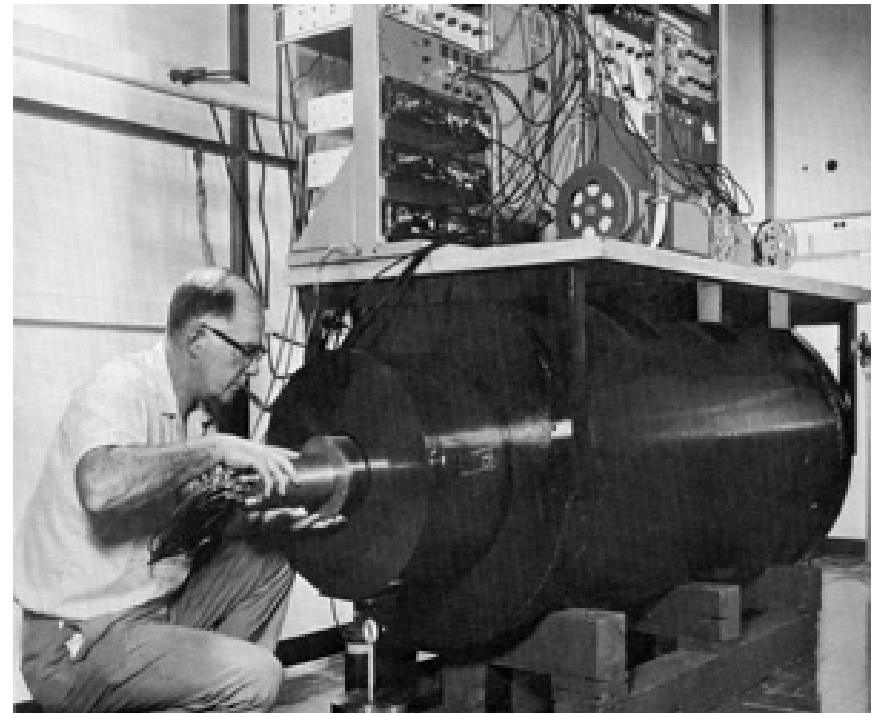
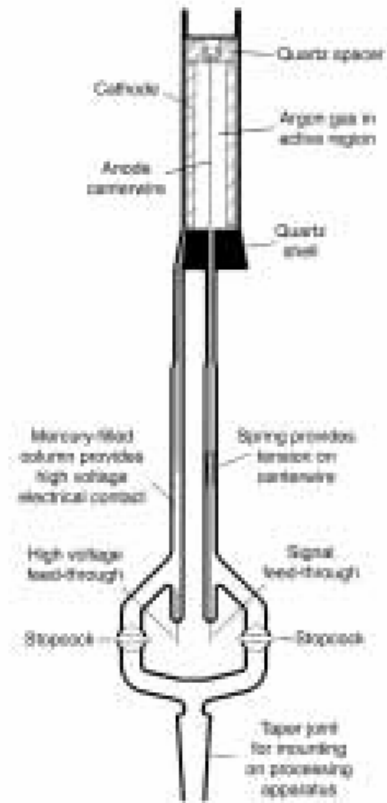

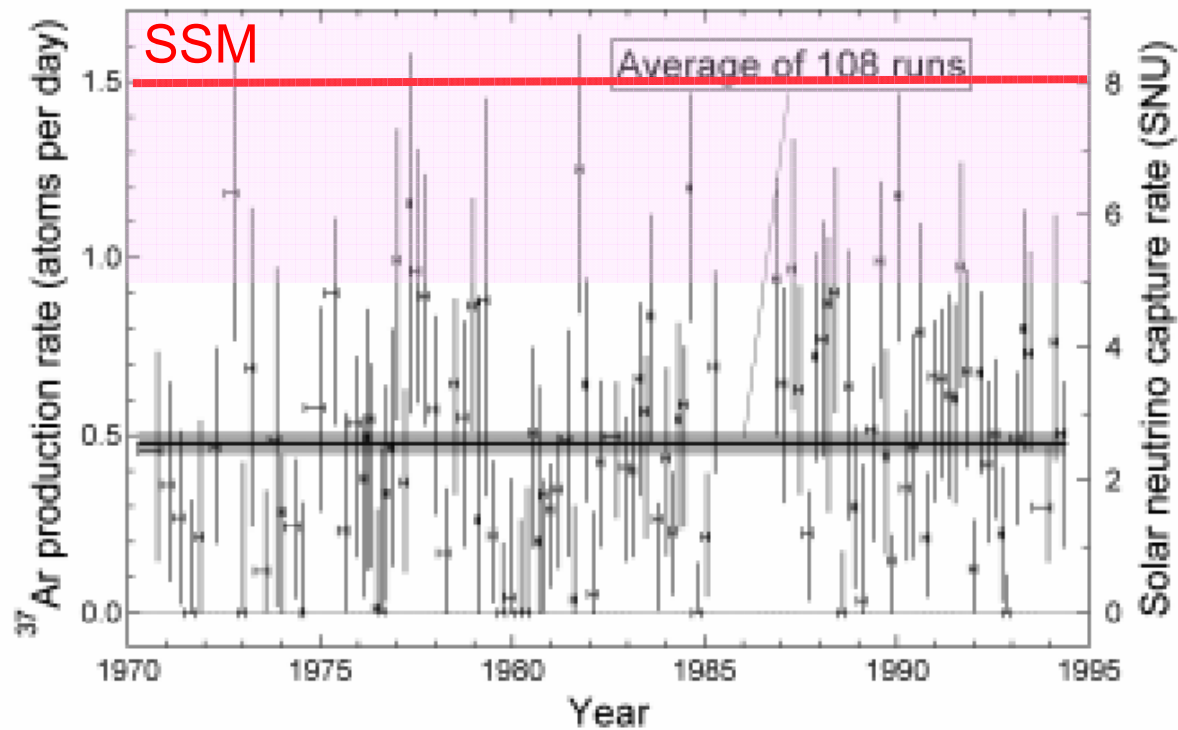
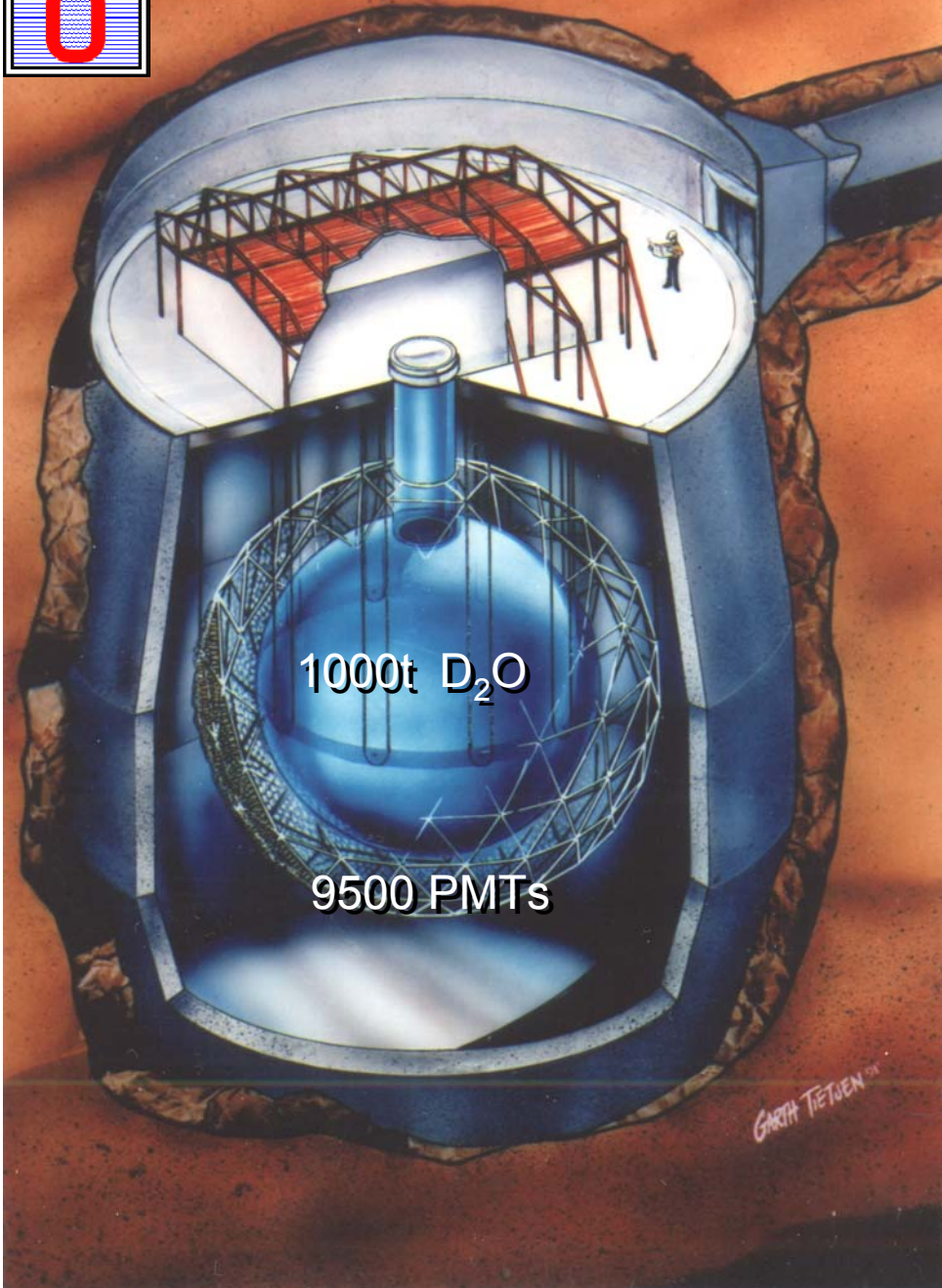

Figure 15. A summary of all of the runs made at Homestake after implementation of rise-time counting. Background has been subtracted. Over a period of 25 years, 2200 atoms of ^{37}Ar were detected, corresponding to an average solar neutrino flux of 2.56 SNU. The gap in 1986 occurred when both perchloroethylene circulation pumps failed. Based on data from Cleveland *et al.* (1998).



SNO

- ^8B solar neutrinos
- first measurement of total flux: $\nu_e + \nu_\mu + \nu_\tau$



Creighton Mine (Nickel)
Sudbury, Canada



Depth 2070m

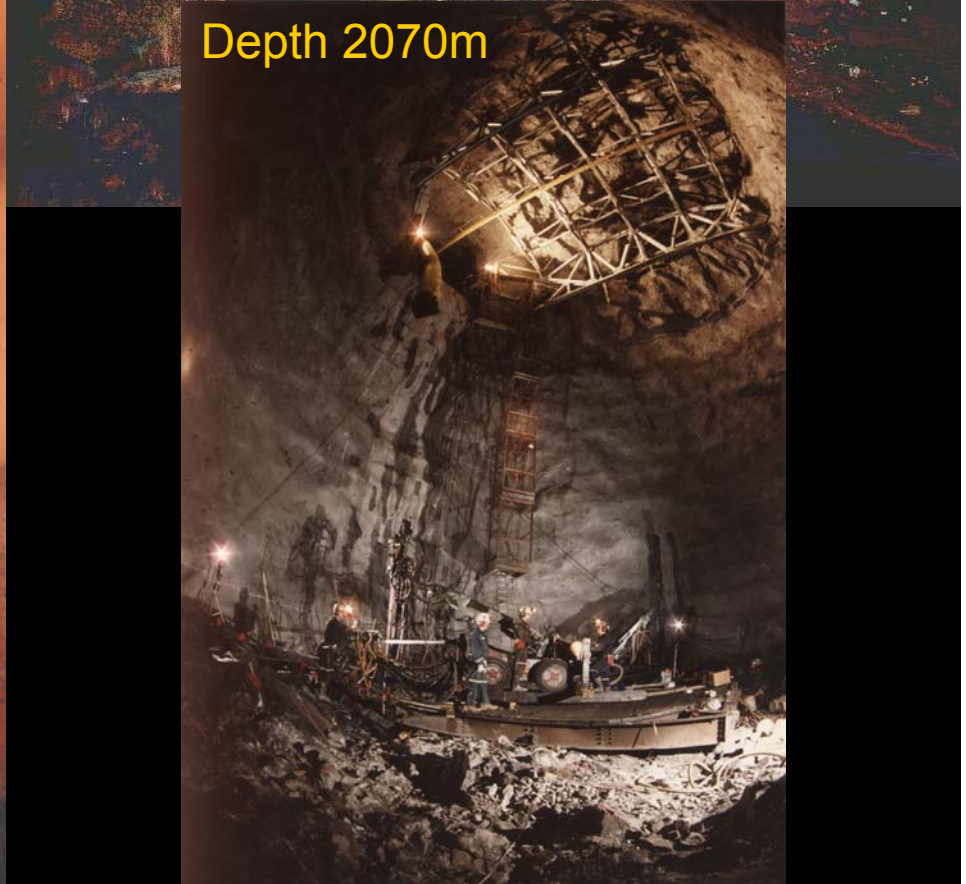



Neutrino detection in SNO

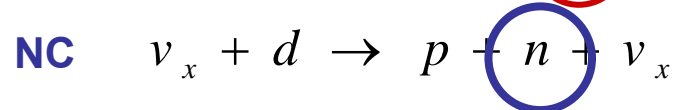
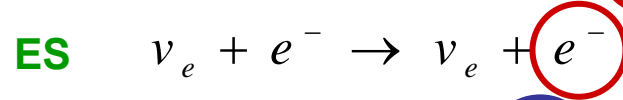
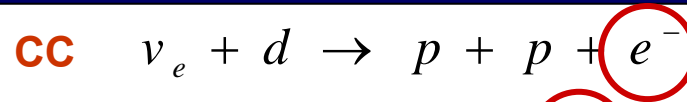

Charged Current/Elastic Scattering

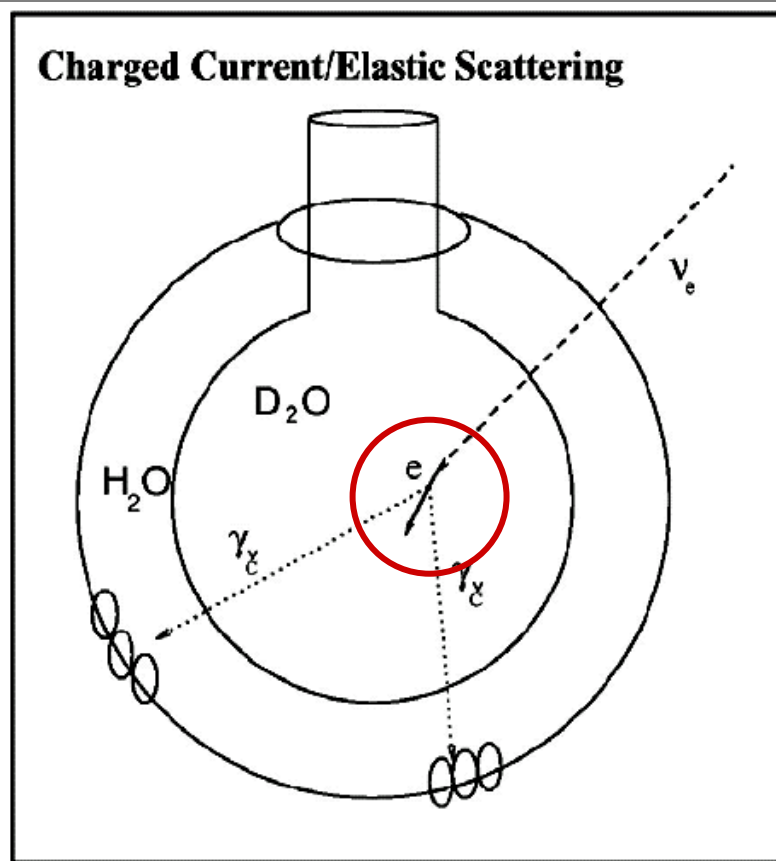

Neutral Current -- Capture in D or Cl

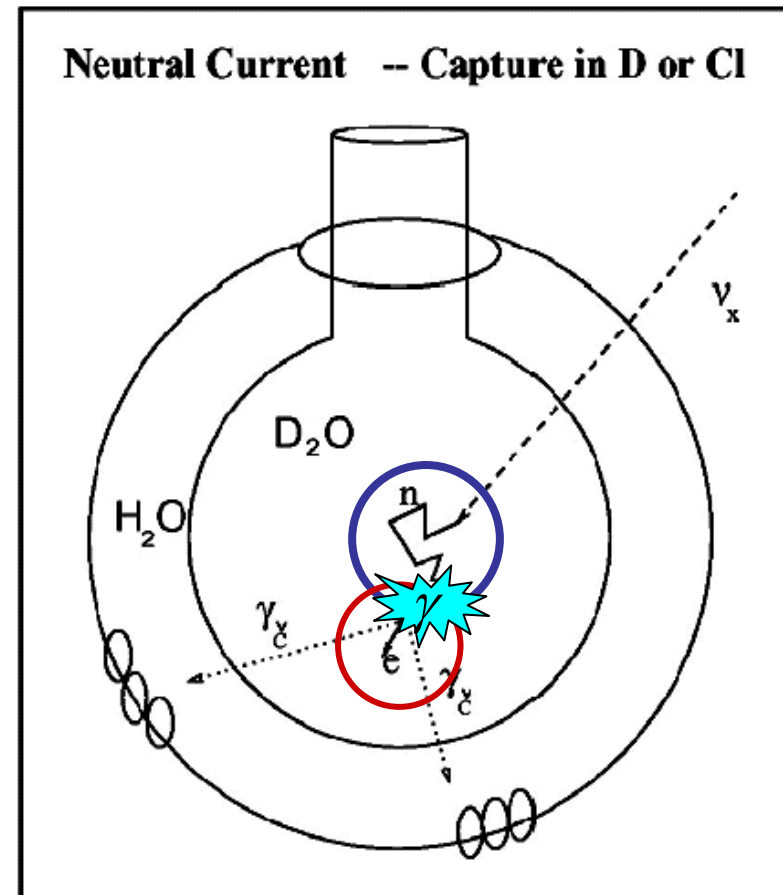



SNO Result (salt-phase)

(PRL 92, 181301, 2004)

$$\phi(^8\text{B})_{\text{meas}} = (0.88 \pm 0.04 (\text{exp}) \pm 0.23 (\text{th})) \phi(^8\text{B})_{\text{SSM}}$$

- 1/3 of solar ν_e arrive as ν_e on Earth
- 2/3 of solar ν_e arrive as ν_μ or ν_τ .
- Measured total flux = Predicted flux
(Standard Solar Model)

New Generation of Solar Neutrino Experiments

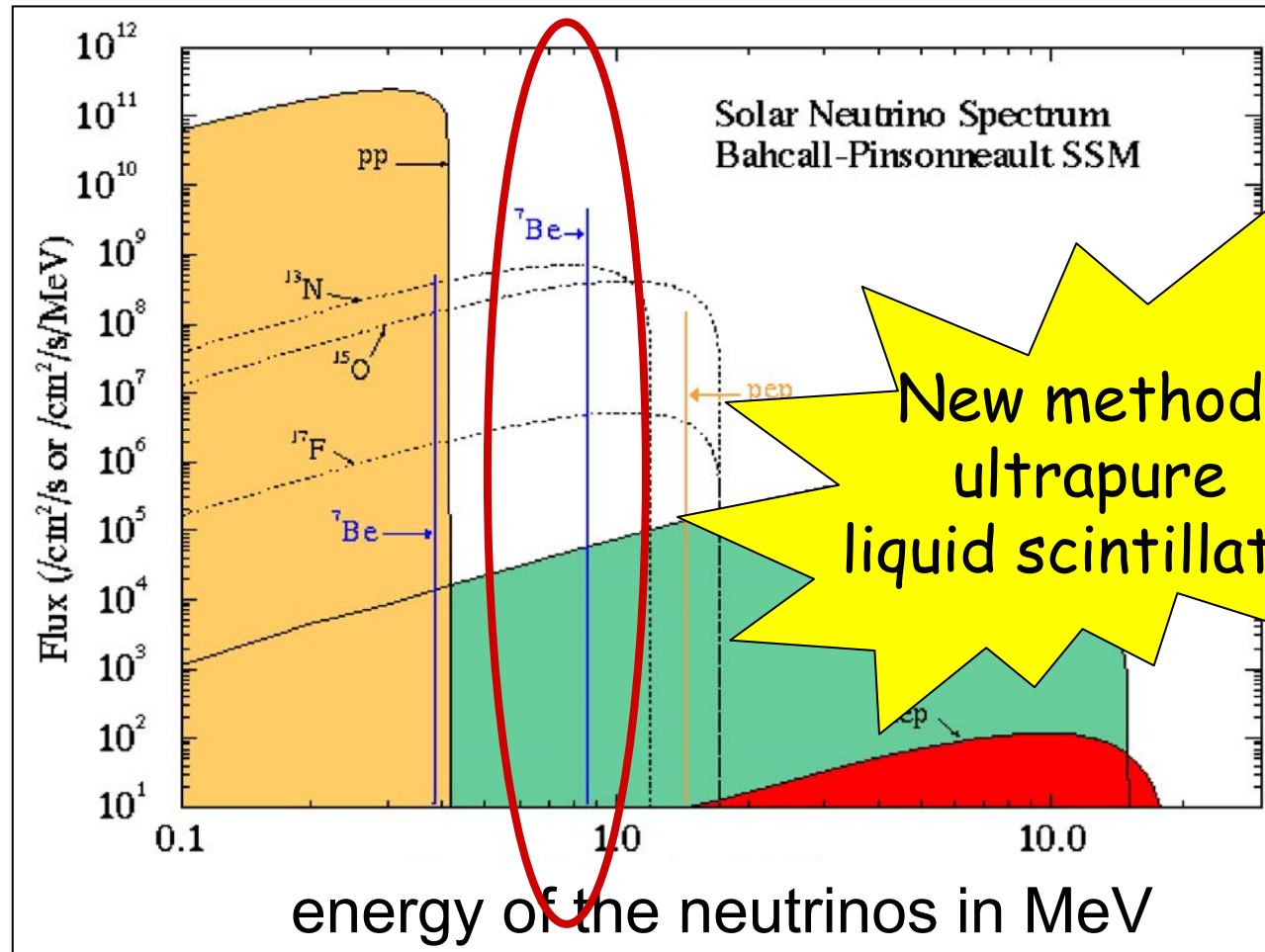

^7Be : $E_\nu = 860 \text{ keV}$, monoenergetic line



BOREXINO

Expected (electron) energy distribution:

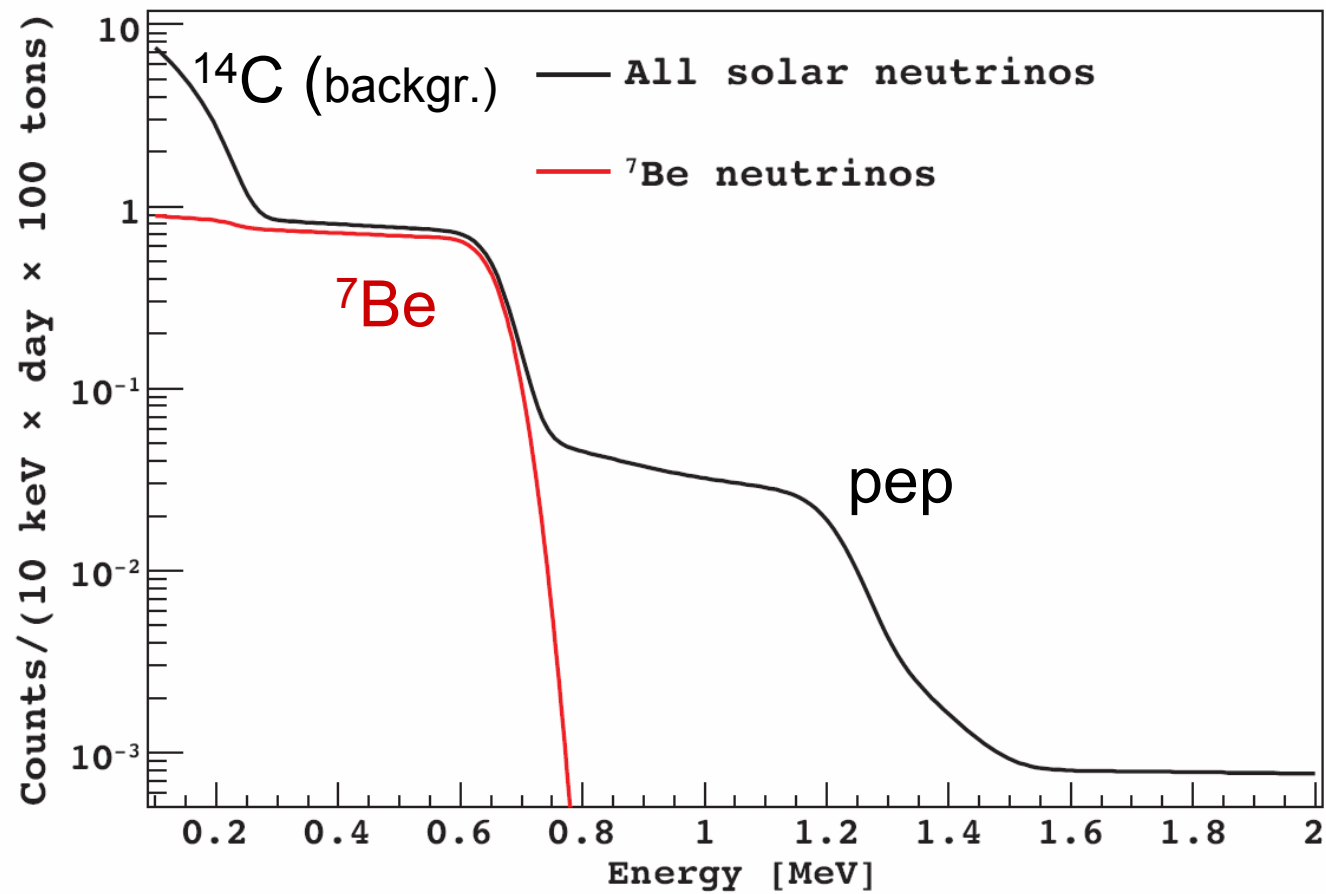

Edge at 665 keV



BOREXINO @ LNGS

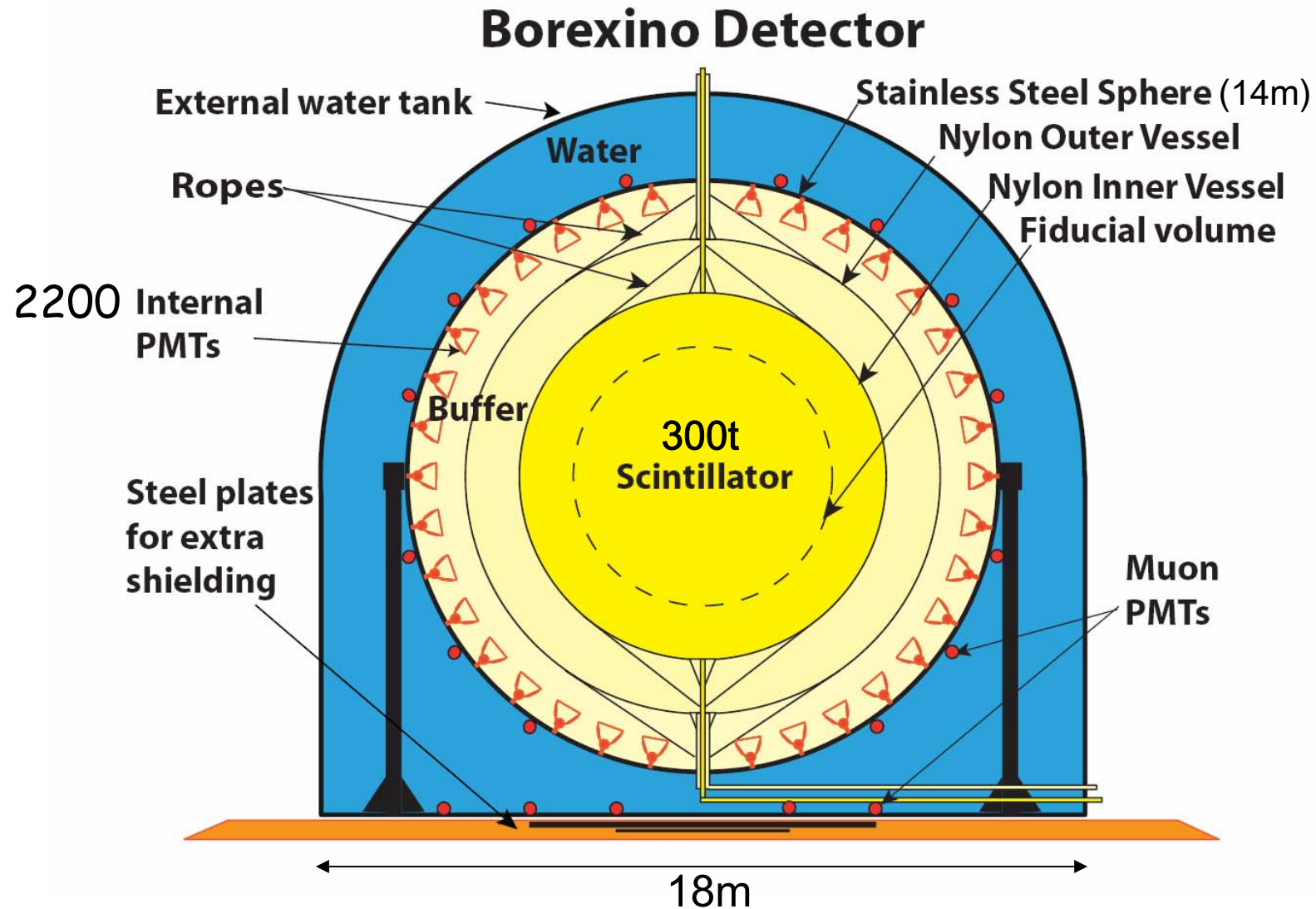



CTF (Borexino)



Photomultipliers and light concentrators in Borexino

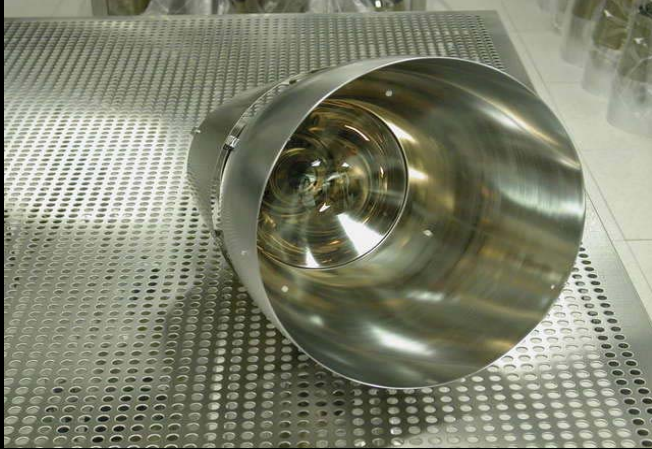

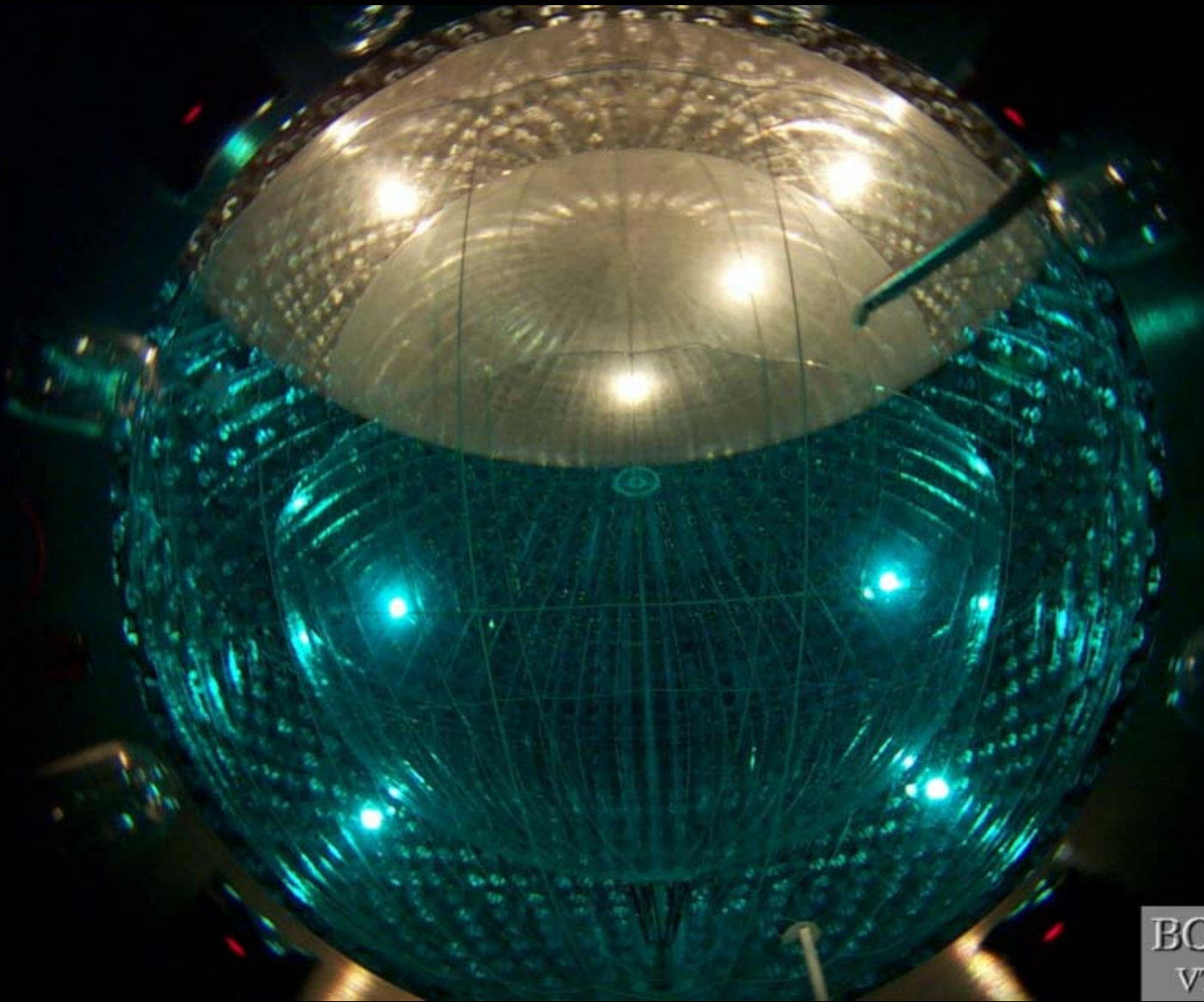

BC
VI

Borexino during filling (on top scintillator, lower part water)



BOREXINO
VT Calibration

Scintillator filling completed May 15, 2007



Recent BOREXINO Result (May 2008)

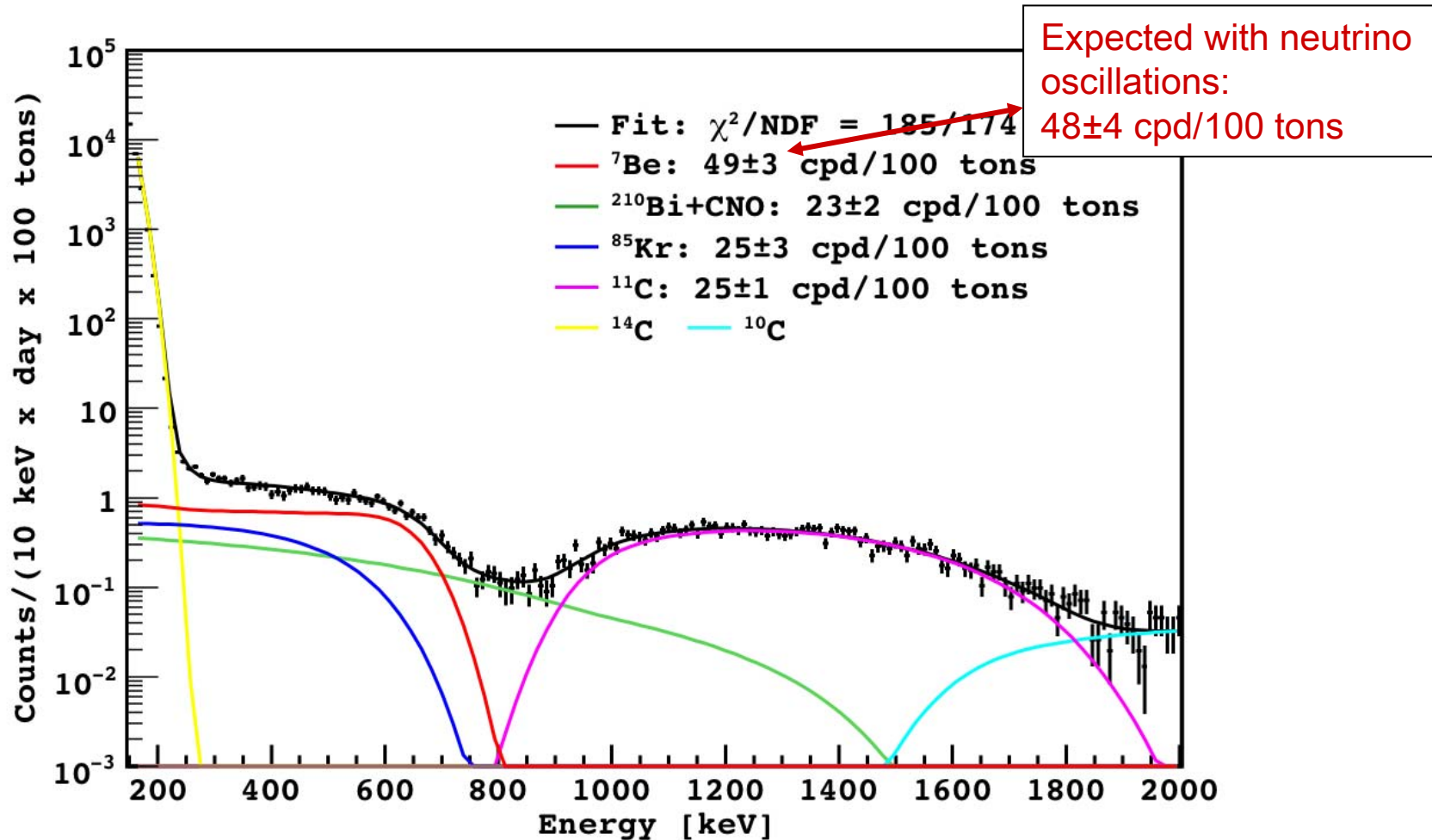

PRL 101:091302 (2008). arXiv:0805.3843:

“New results on solar neutrino fluxes from 192 days of Borexino data”

KAMLAND
Reactor neutrino experiment
to confirm
solar neutrino oscillation

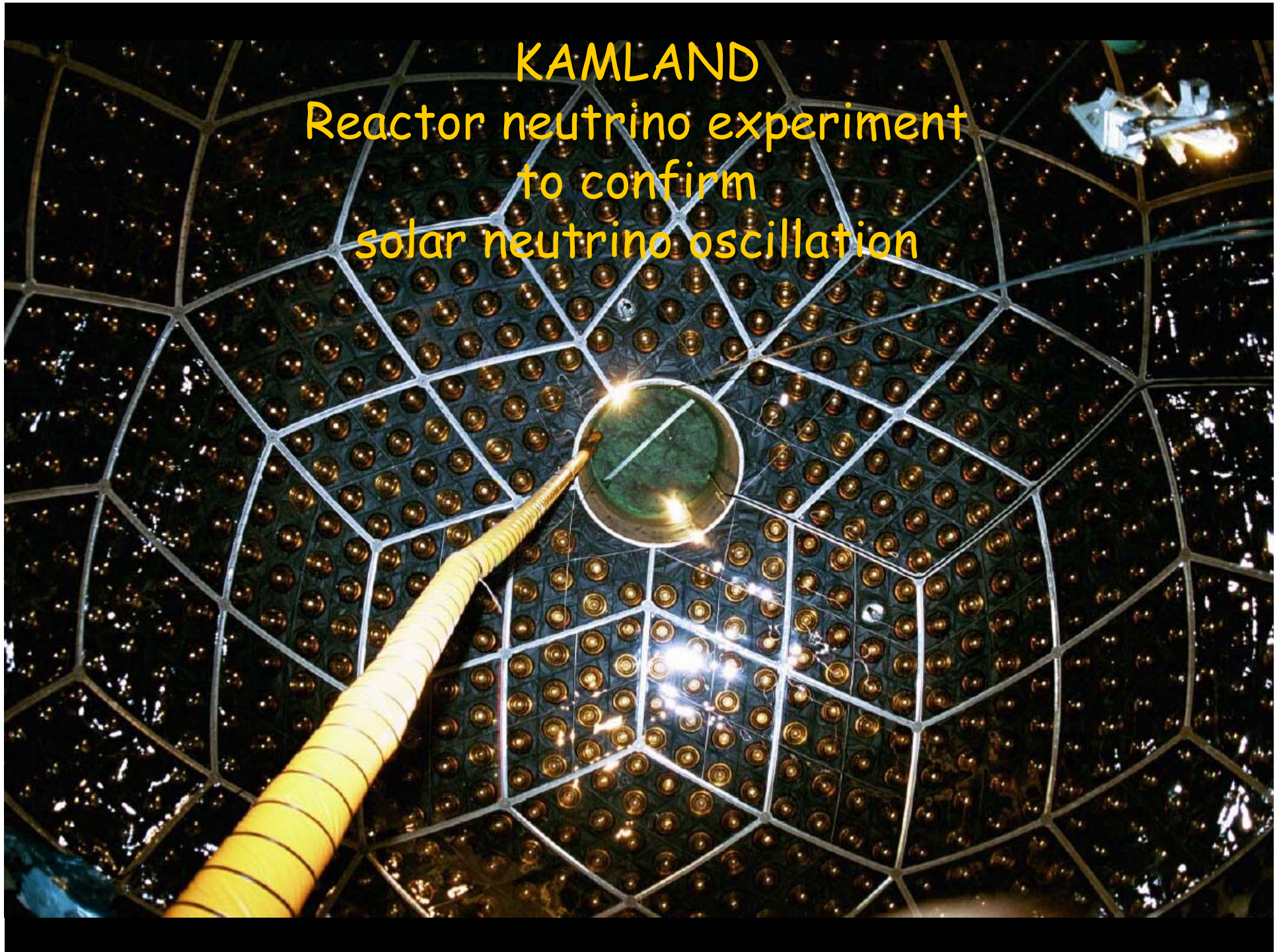

KAMLAND

reactor neutrinos = $\bar{\nu}_e$

Reactor ν_e spectrum (a.u.)

Observed spectrum (a.u.)

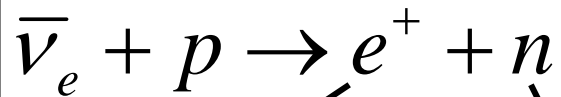
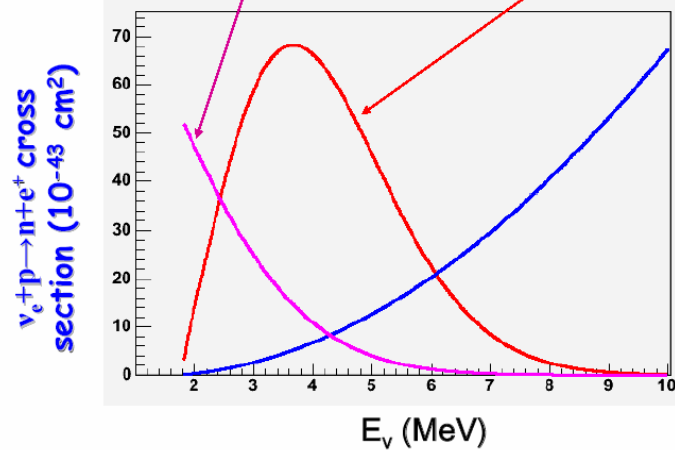

prompt signal
 $E_\nu - 0.77\text{MeV}$

delayed signal
 $n + p \rightarrow d + \gamma(2.2\text{MeV})$

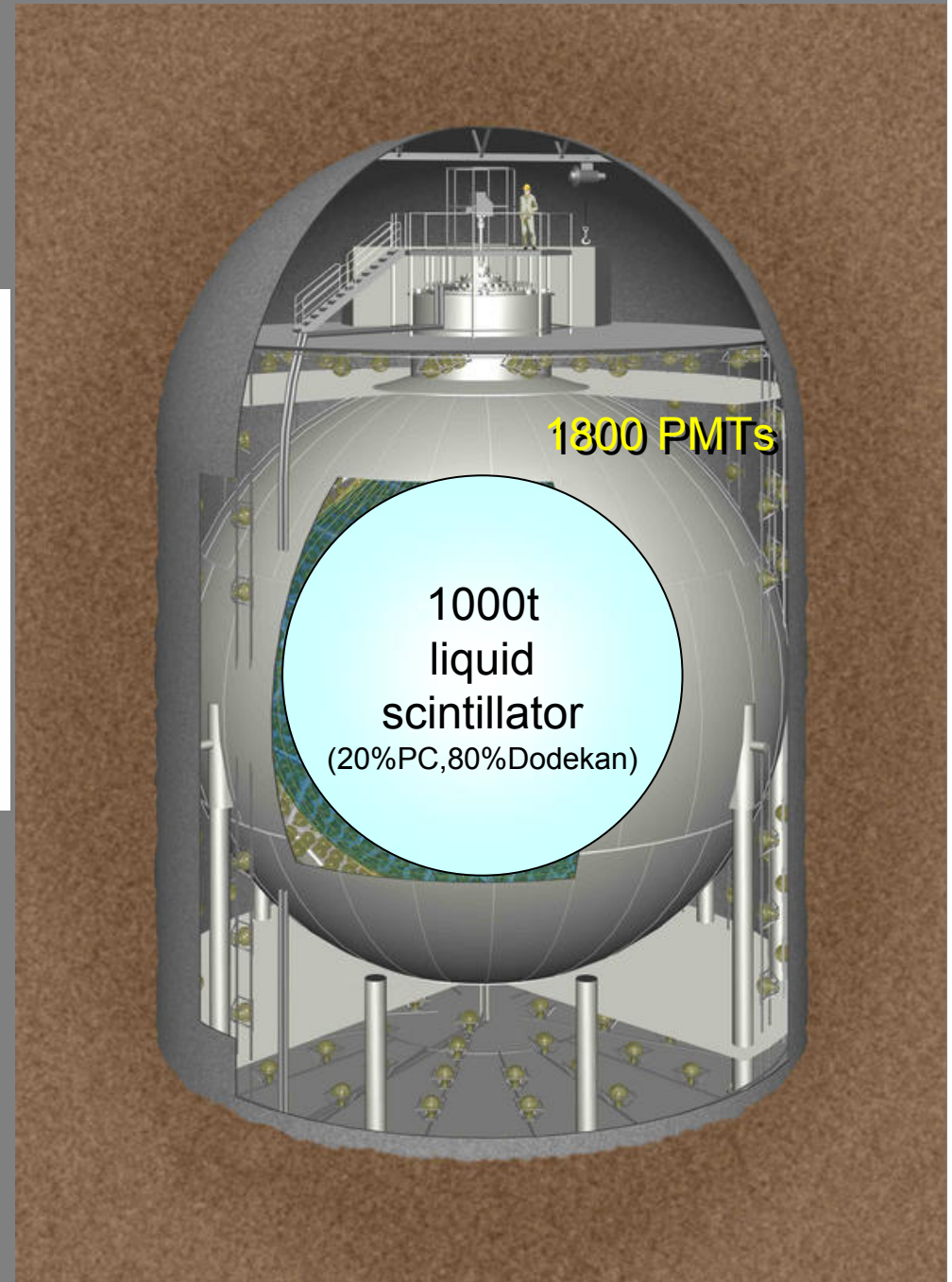

Average distance
of reactors from KamLAND:
175km



Site	Dist (km)	Rate noosc* (yr ⁻¹ kt ⁻¹)
Kashiwazaki	160	254.0
Ohi	179	114.3
Takahama	191	74.3
Tsuruga	138	62.5
Hamaoka	214	62.0
Mihama	146	62.0
Sika	88	55.2
Fukushima1	349	31.1
Fukushima2	345	29.5
Tokai2	295	10.1
Onagawa	431	9.3
Simane	401	6.3
Ikata	561	5.1
Genkai	755	4.8
Sendai	830	2.1
Tomari	783	1.4

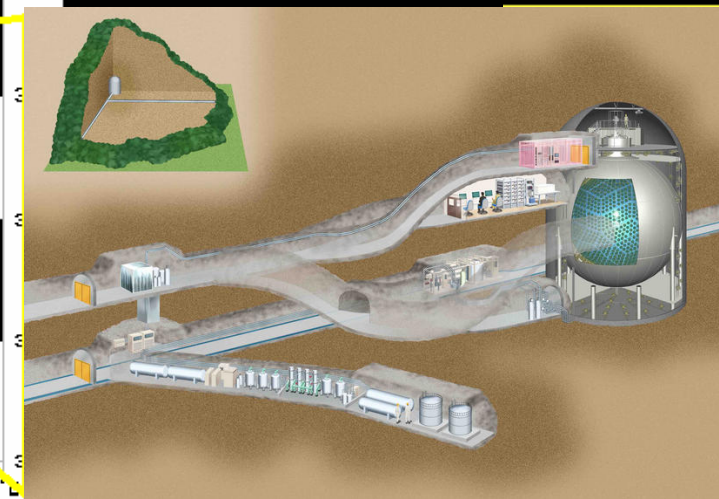

International Nuclear Safety Center at ANL, Mar 1, 99

Test of solar Neutrino-Oscillations with Reactor Neutrinos

Average distance of japanese nuclear reactors
from KamLAND detector:
175km

$$L_{osz}^{vac} [\text{m}] = \frac{2.48 \cdot E_{\nu} [\text{MeV}]}{\Delta m^2 [\text{eV}^2]}$$

$$E (\text{Reactor } \nu) \approx 4 \text{MeV}$$
$$\Delta m^2 (\text{solar } \nu) = 8 \cdot 10^{-5} \text{eV}^2$$

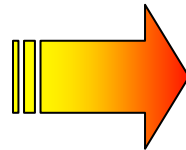

$$L_{osz} \approx \frac{2.5 \cdot 4}{8 \cdot 10^{-5}} \text{m} = 125 \text{km}$$

Test possible!

KamLAND result (2008)

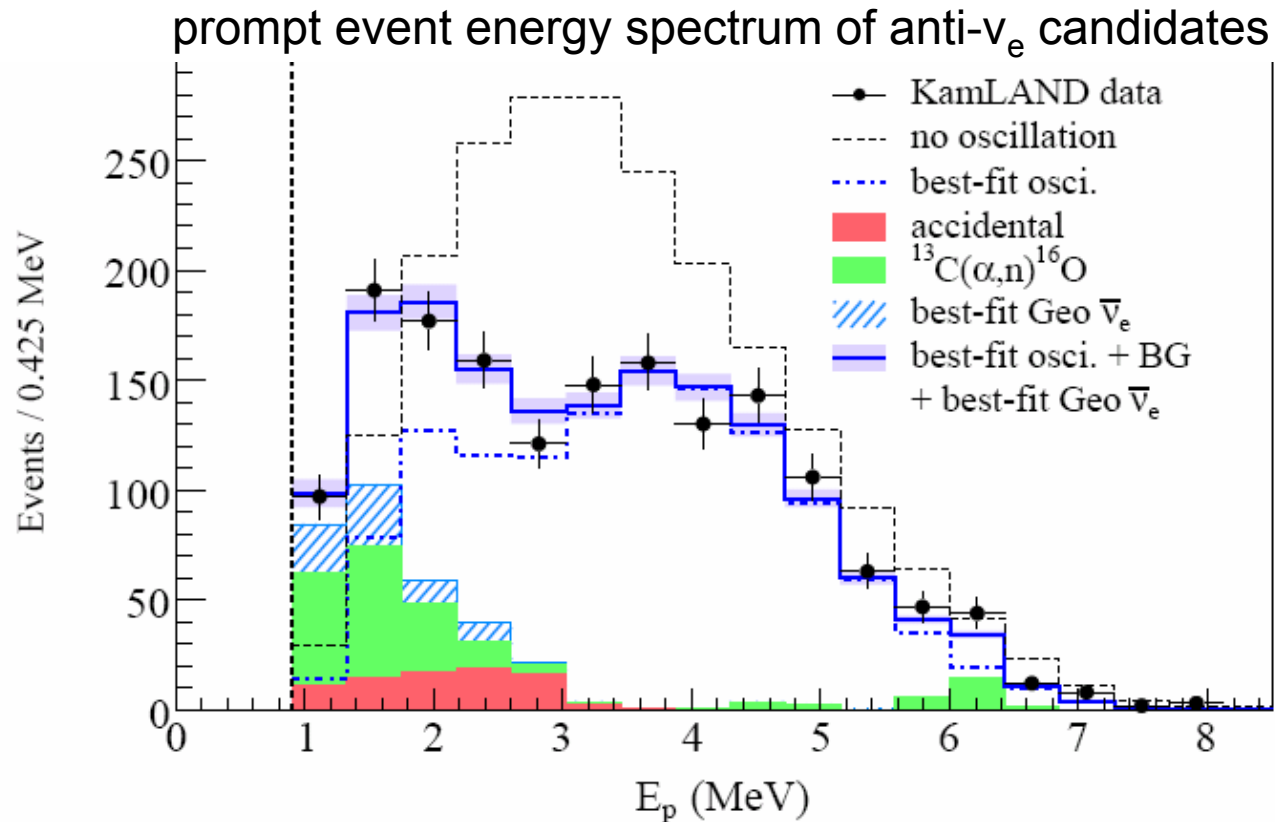

best fit: $\Delta m_{21}^2 = 7.58^{+0.14}_{-0.13} (\text{stat})^{+0.15}_{-0.15} (\text{syst}) \times 10^{-5} \text{ eV}^2$

$\tan^2 \theta_{12} = 0.56^{+0.10}_{-0.07} (\text{stat})^{+0.10}_{-0.06} (\text{syst})$

„Precision Measurement of Neutrino Oscillation Parameters with KamLAND“, Phys.Rev.Lett.100:221803,2008

KamLAND result (2008)

„Precision Measurement of Neutrino Oscillation Parameters with KamLAND“, Phys.Rev.Lett.100:221803,2008

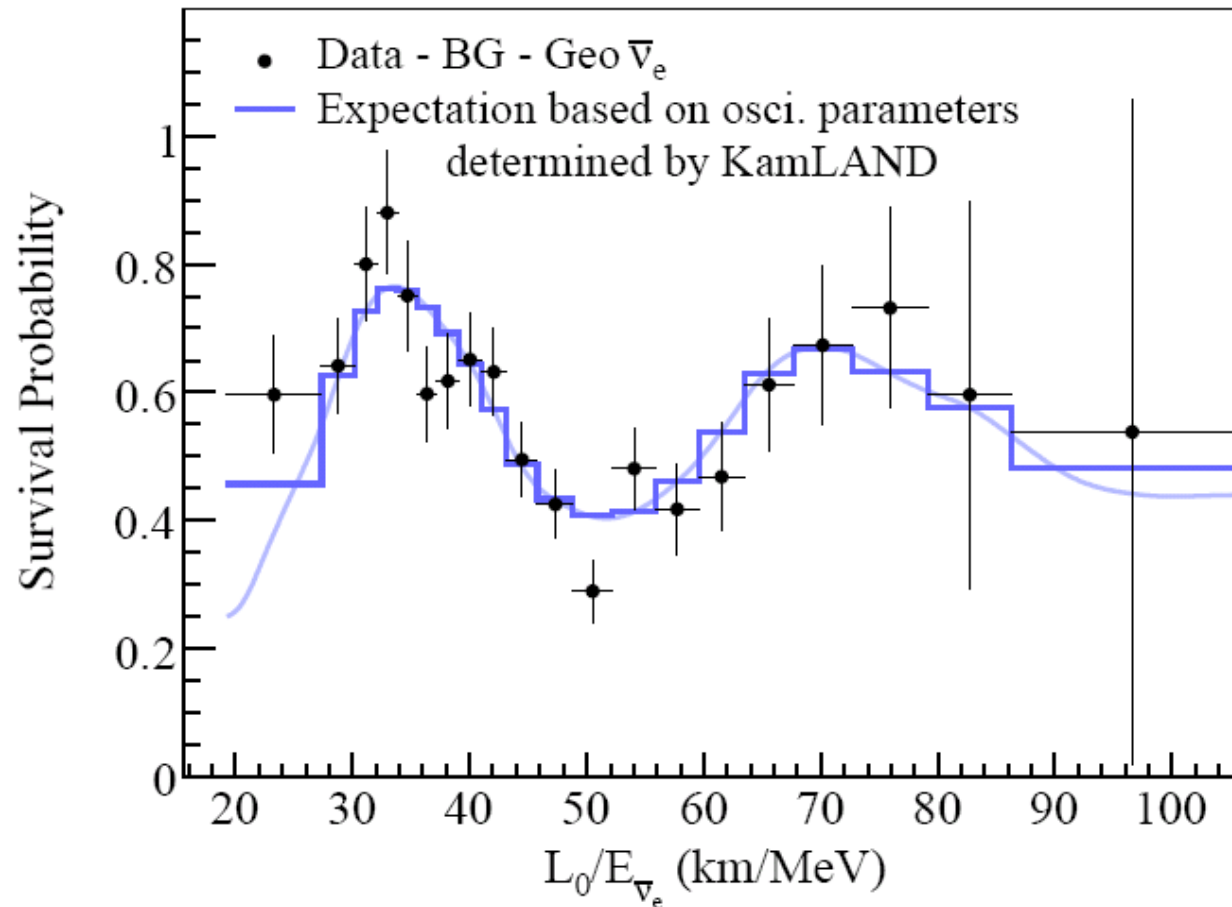

L_0 is the „effective“ baseline = flux-weighted average of distance = 180km

KamLAND result (2008)

„Precision Measurement of Neutrino Oscillation Parameters with KamLAND“, Phys.Rev.Lett.100:221803,2008

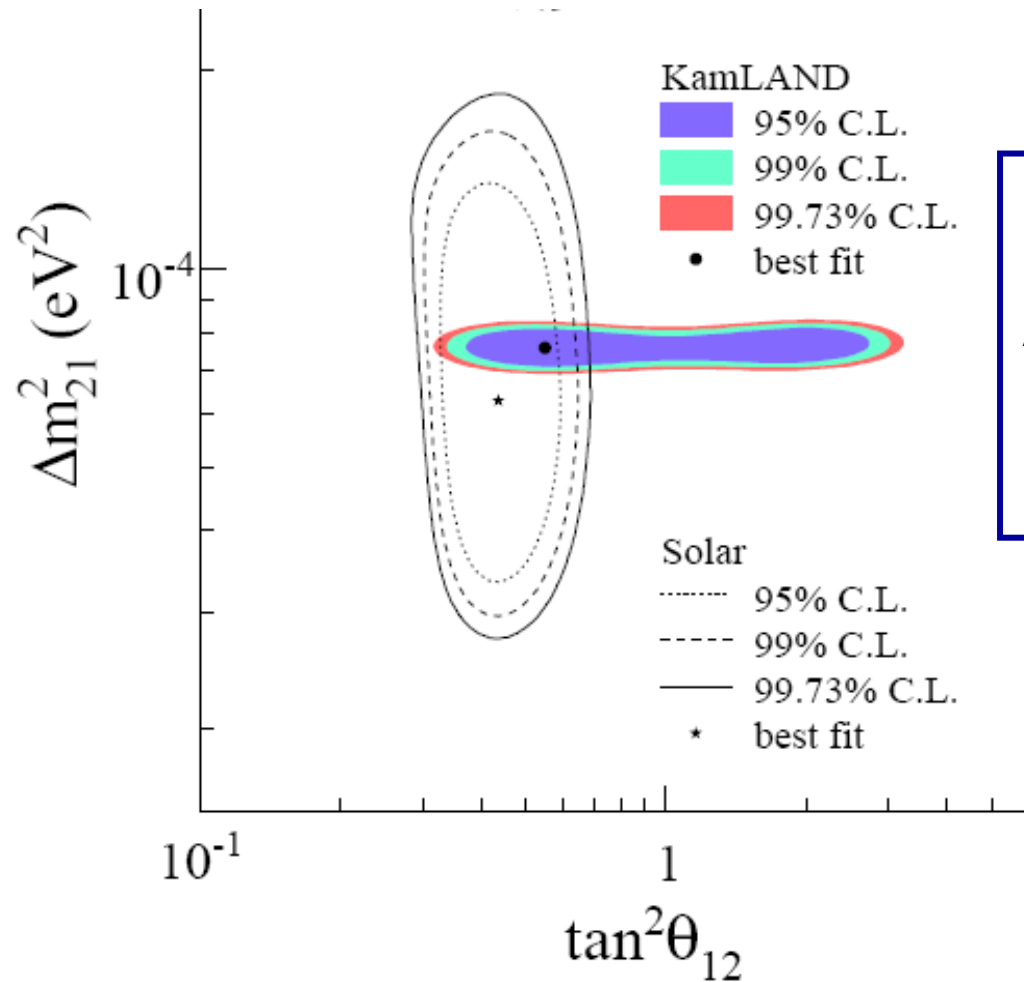

KamLAND + solar:

$$\Delta m_{21}^2 = 7.59_{-0.21}^{+0.21} \times 10^{-5} \text{ eV}^2$$

$$\tan^2 \theta_{12} = 0.47_{-0.05}^{+0.06}$$

Summary

- Neutrino Oscillations have been observed with solar, atmospheric, reactor and accelerator neutrinos.
- Neutrinos have mass!
The absolute neutrino mass has not yet been measured, allowed range: $0.05 \text{ eV} < m_\nu < 2 \text{ eV}$
- Neutrino mixing exists and is very different from quark mixing. Why?
- The third mixing angle must be measured
- Is there CP-violation for neutrinos?
- Is the neutrino a Majorana particle?
Search for neutrinoless Double-Beta Decay (Evidence?)

Many interesting results expected in next years
Many questions still waiting to be solved by some of you!